

# MH 3M - MH 4M

# MH 5M - MH 6P - MH 7P

## Instructions for use

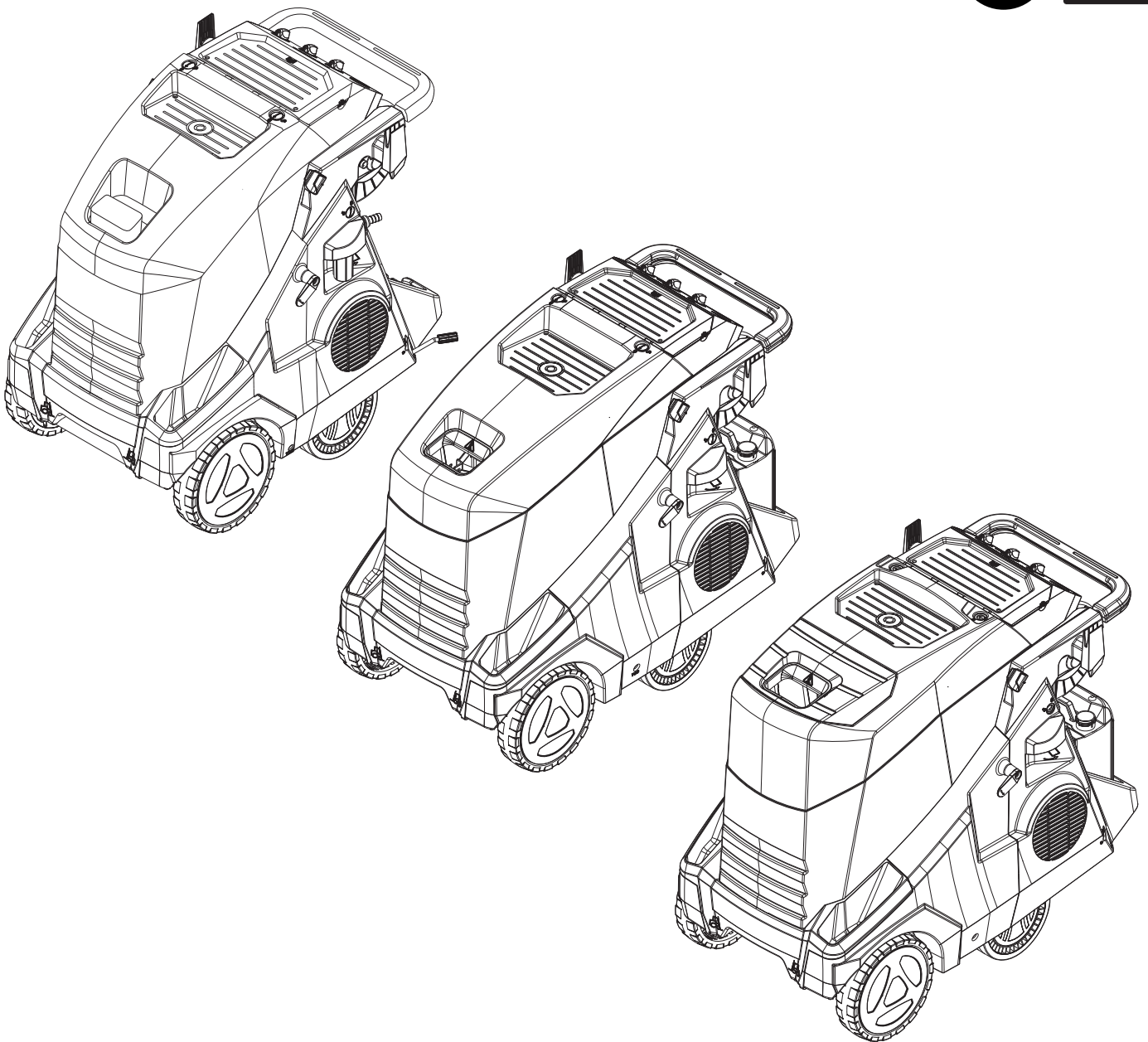

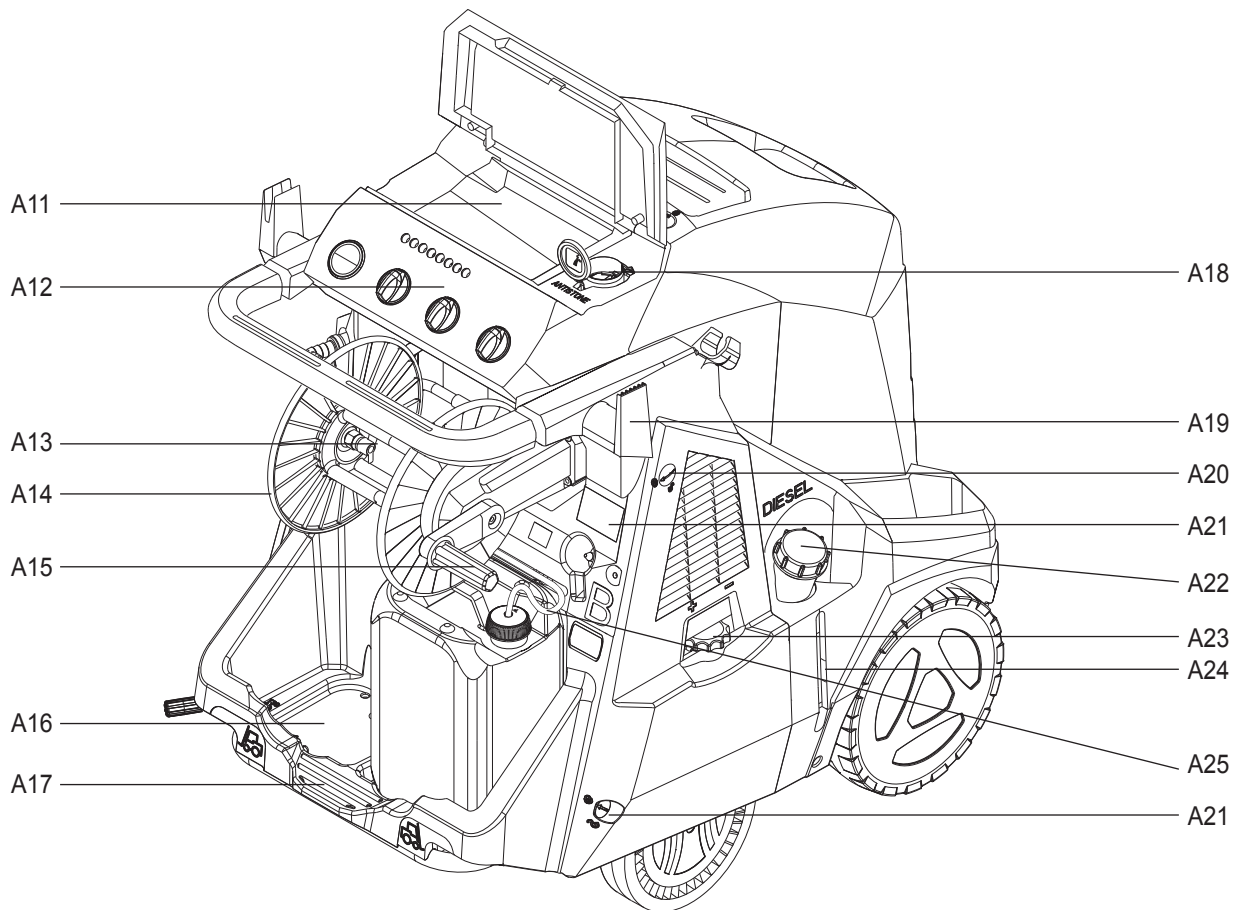
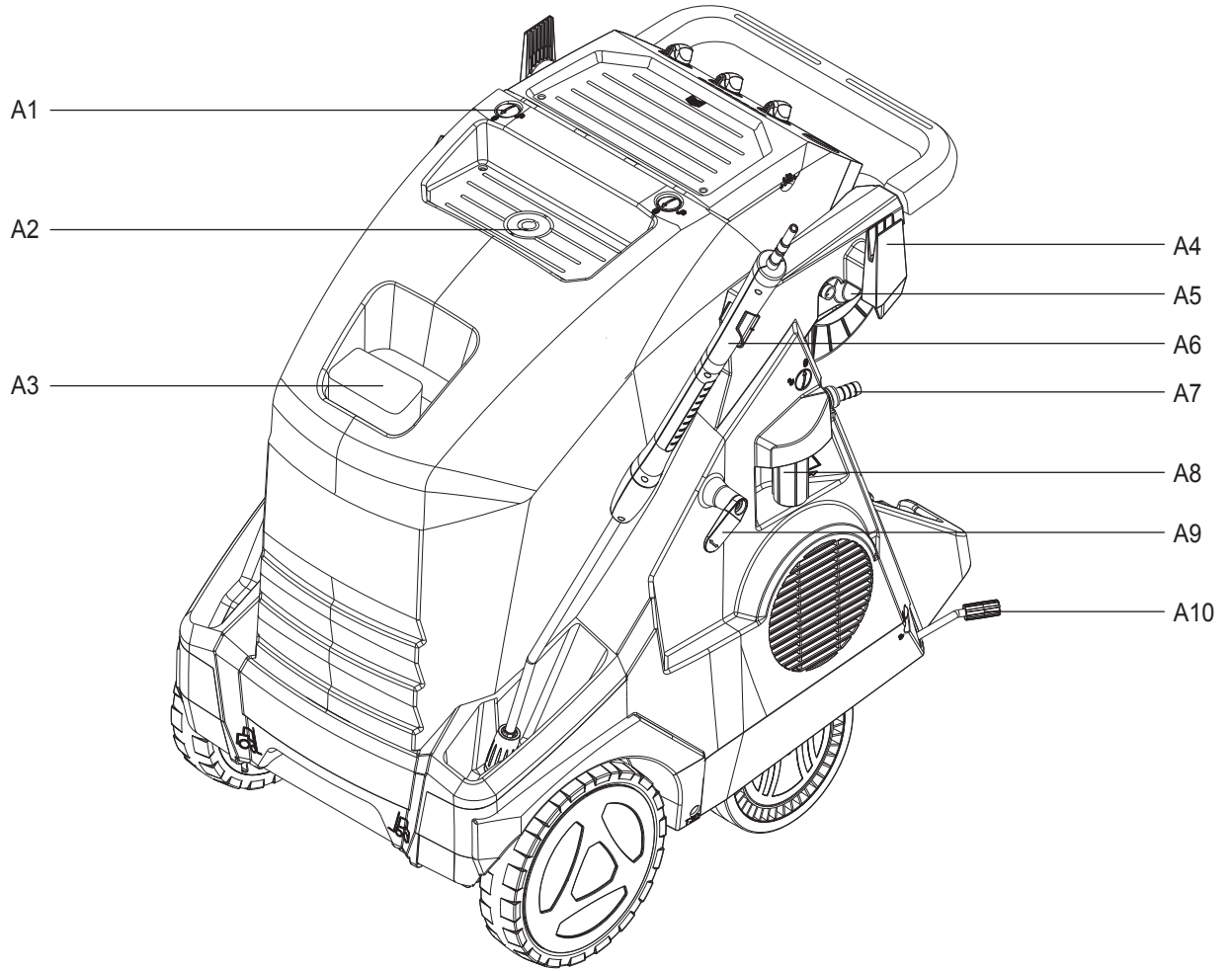

**A**

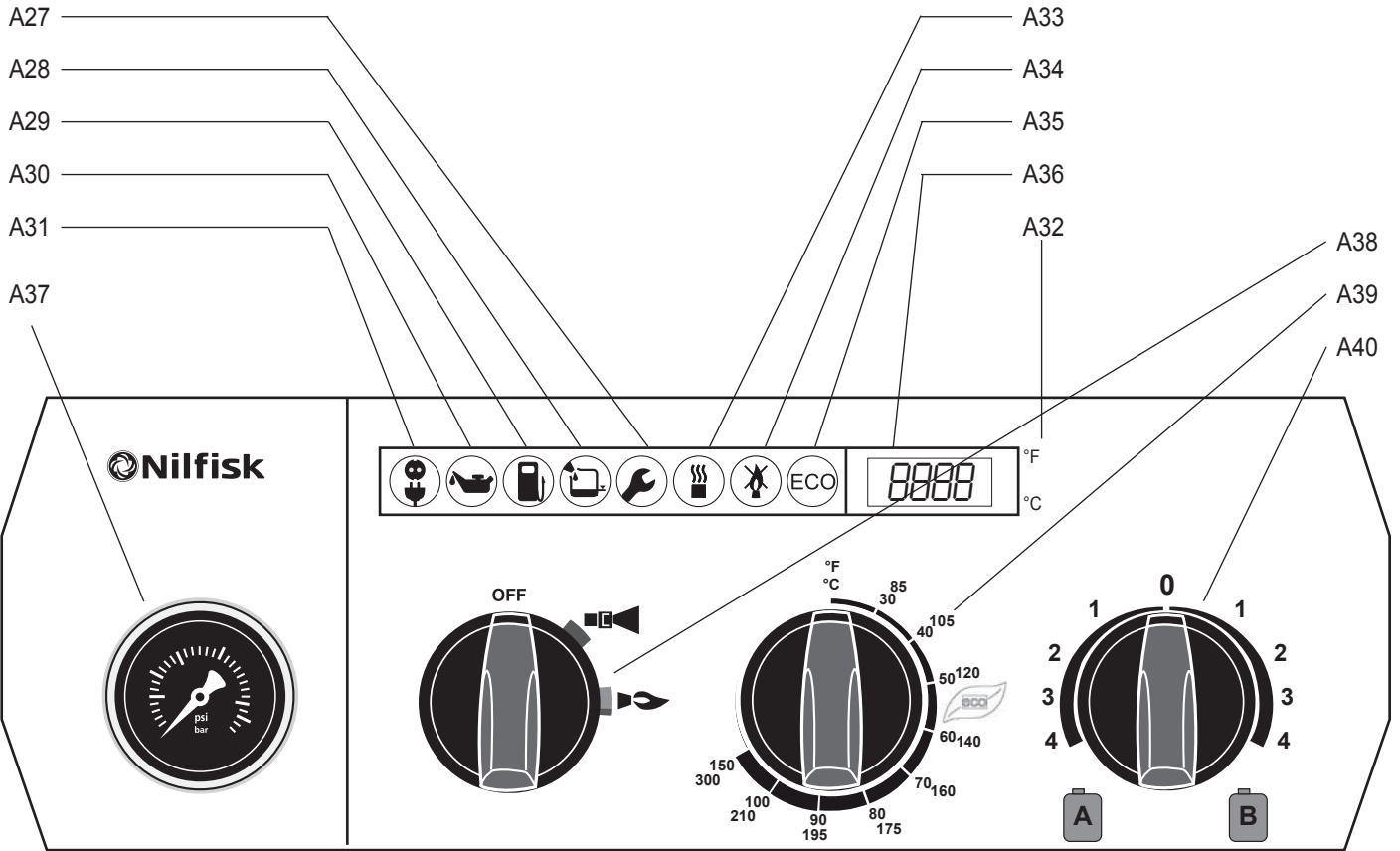

**B**

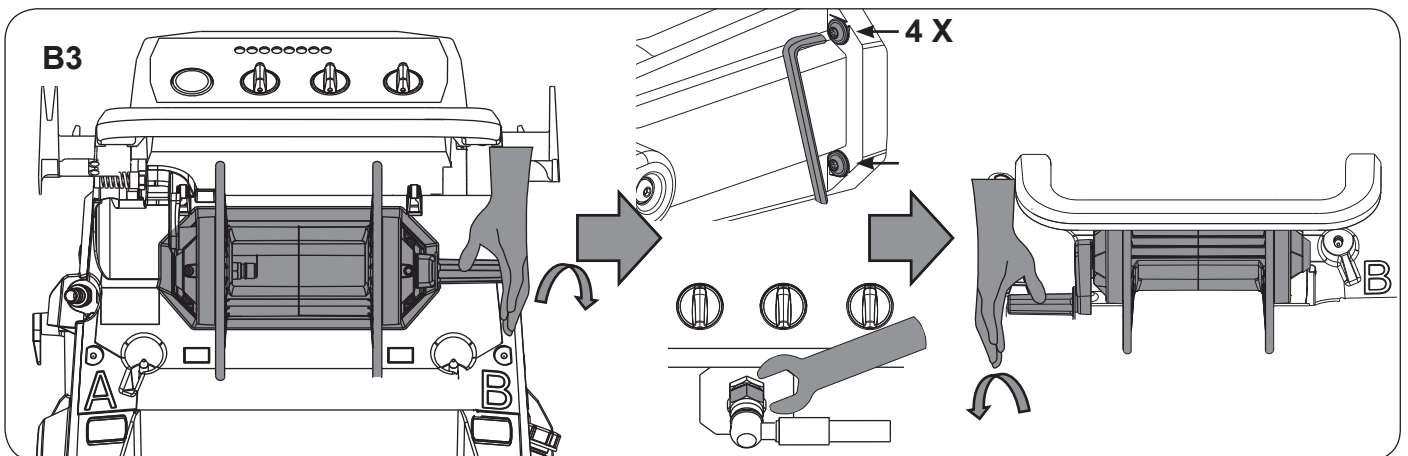
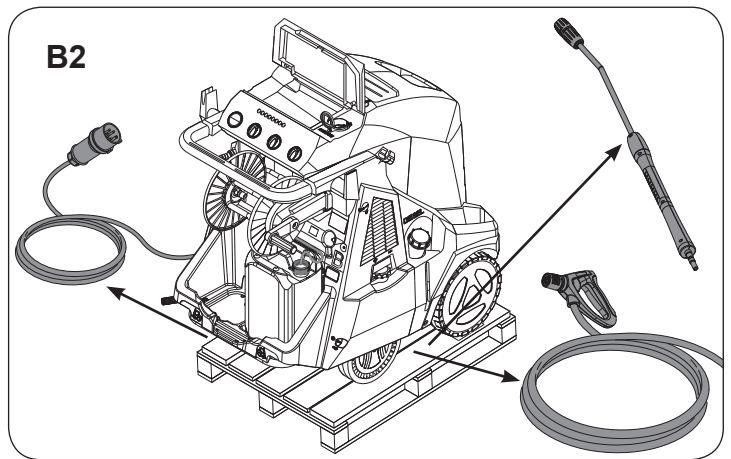
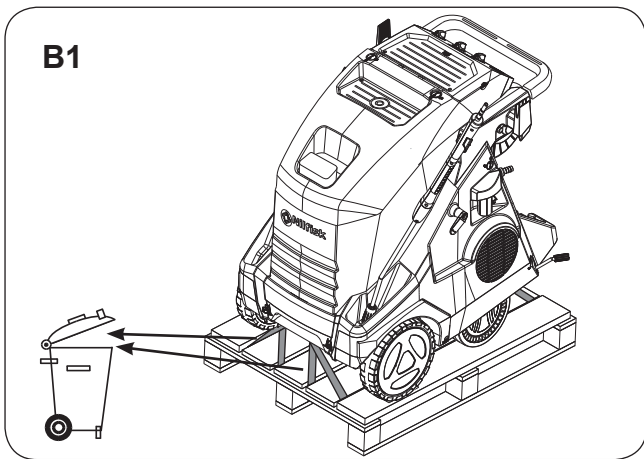

B4.a

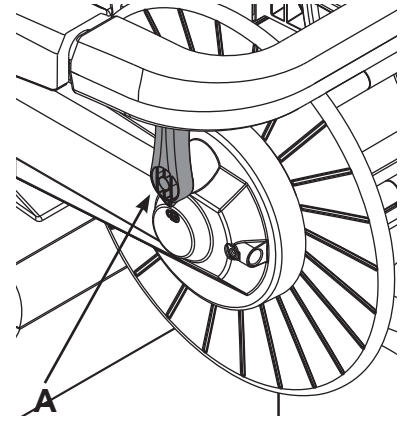
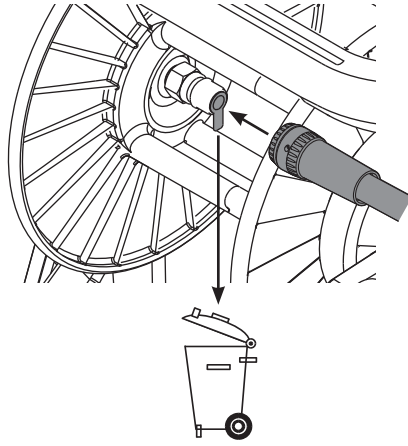
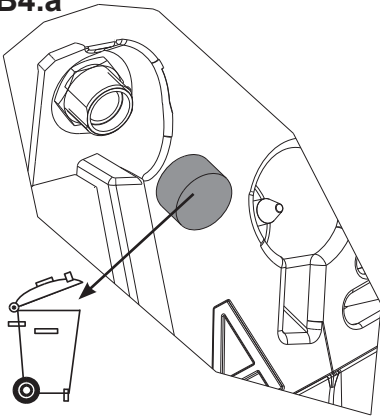

B4.b

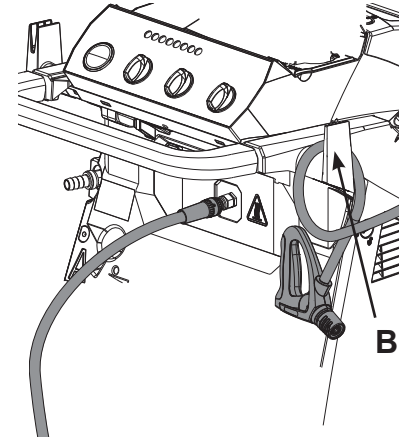
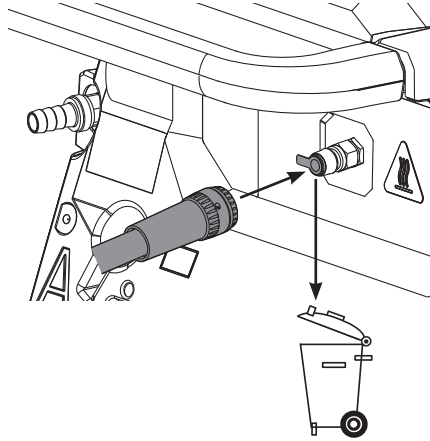
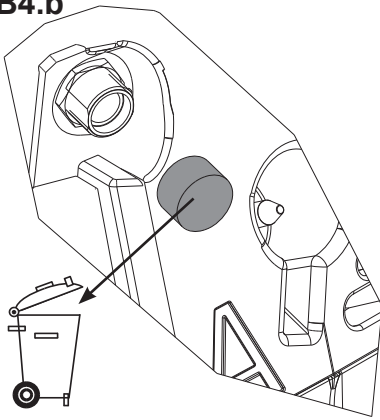

B5

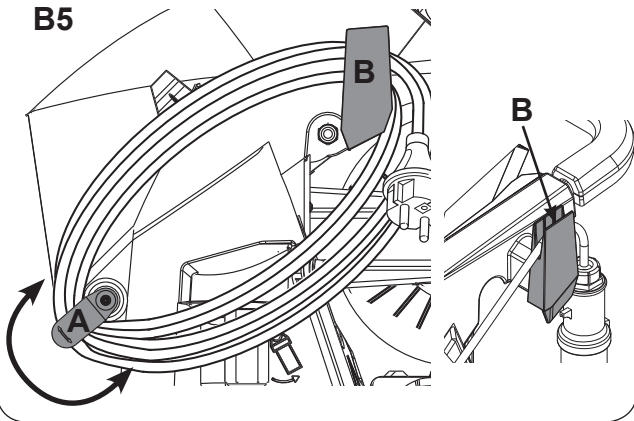

B6

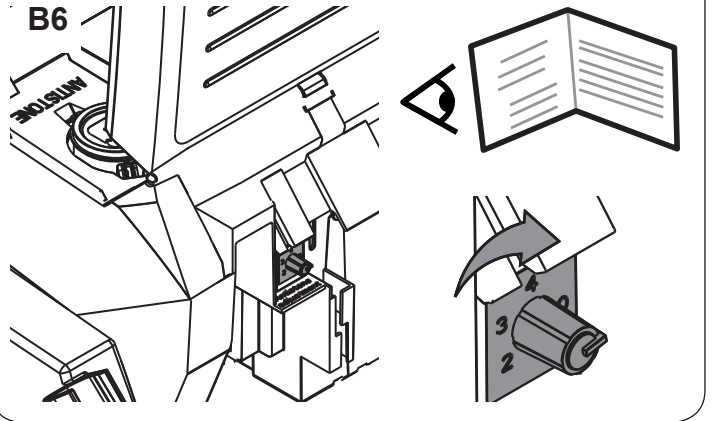



**B**

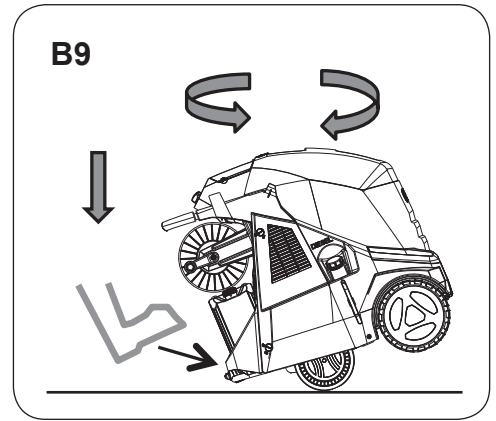
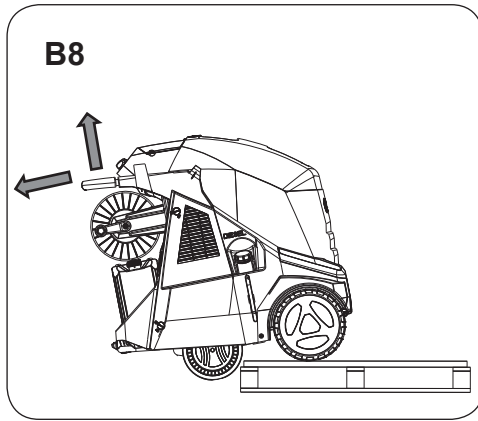
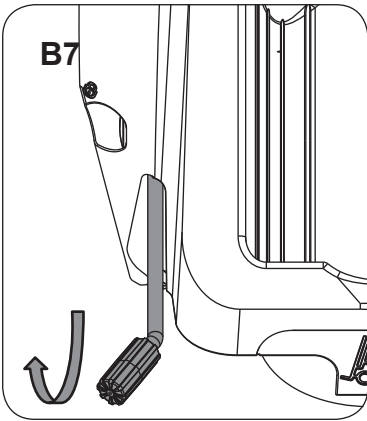

**C**

**C1.a**

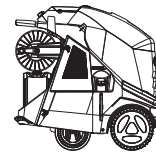
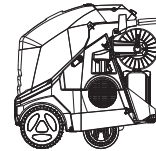
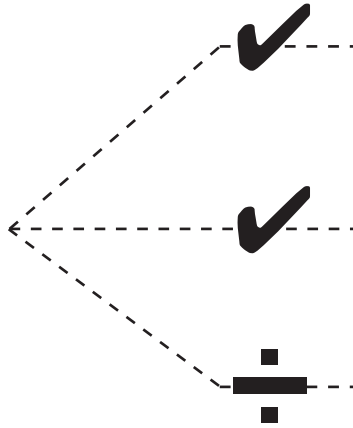
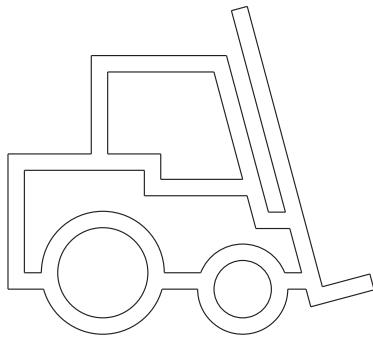

**C1.b**

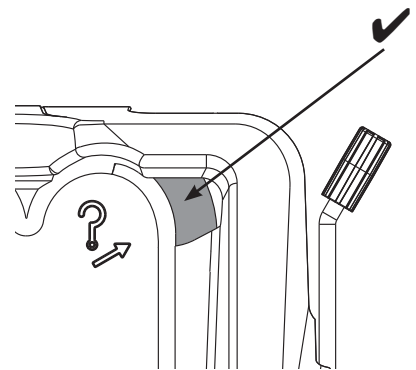
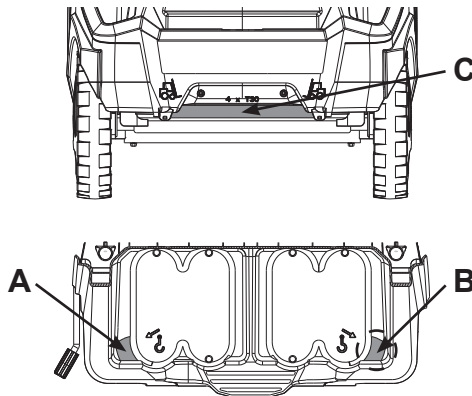
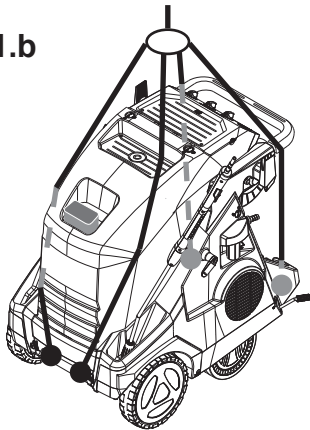

**C1.c**

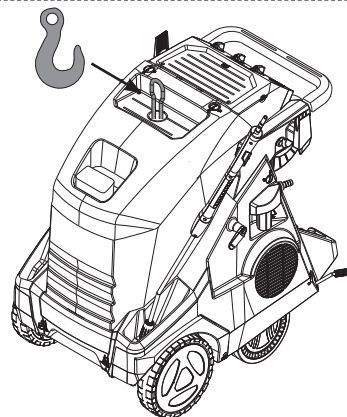
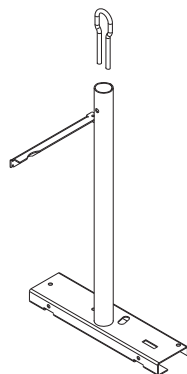

C

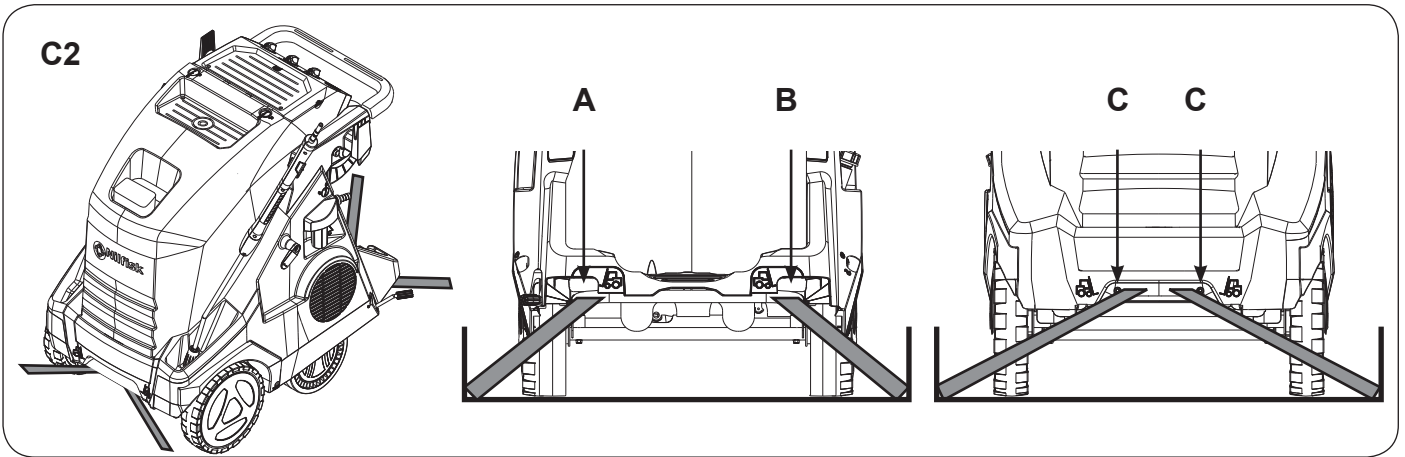

D

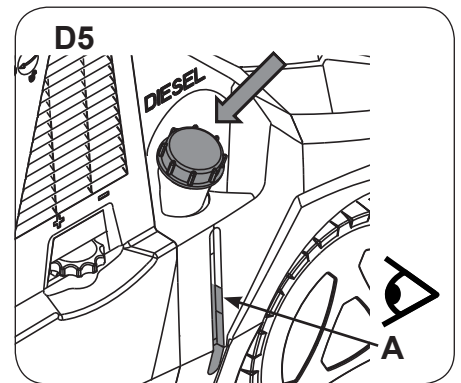
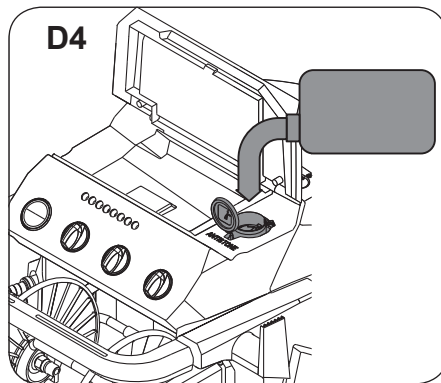
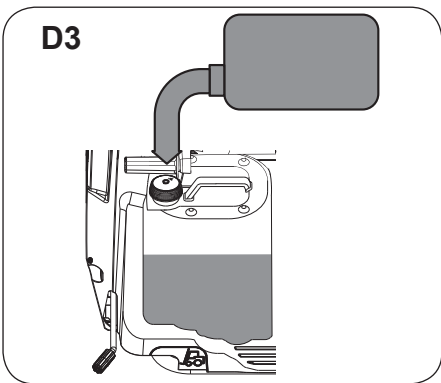
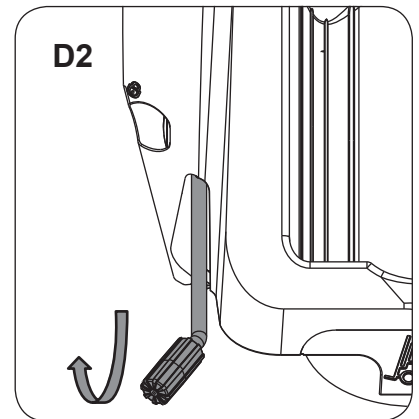
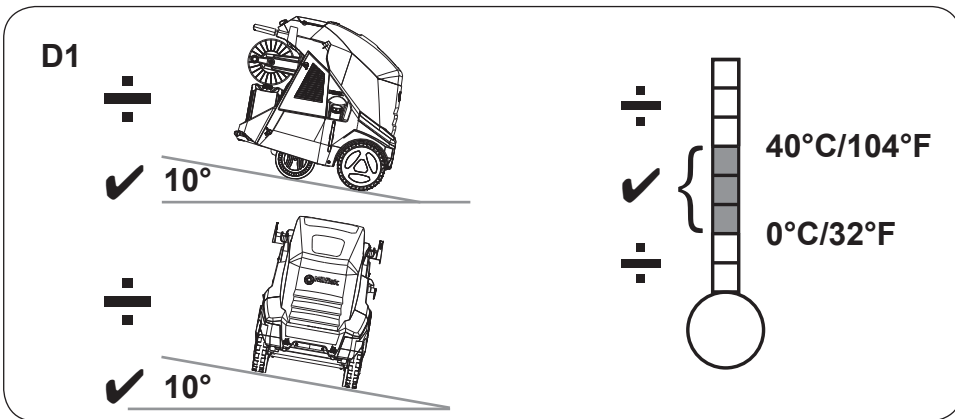

E

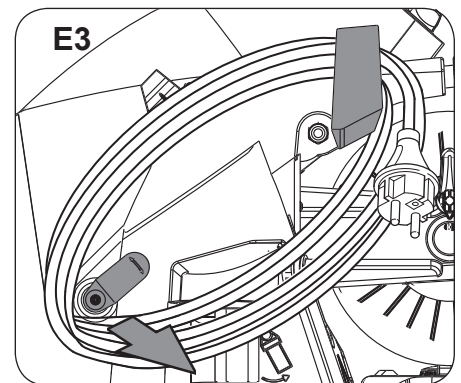
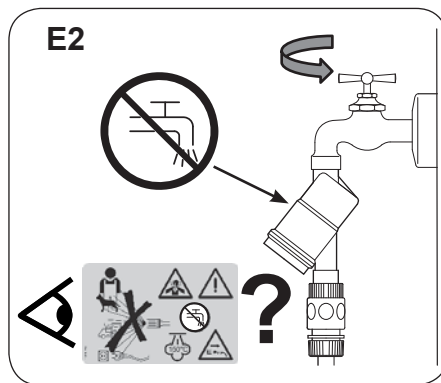
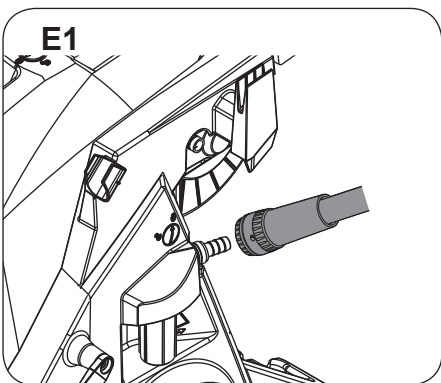

E4

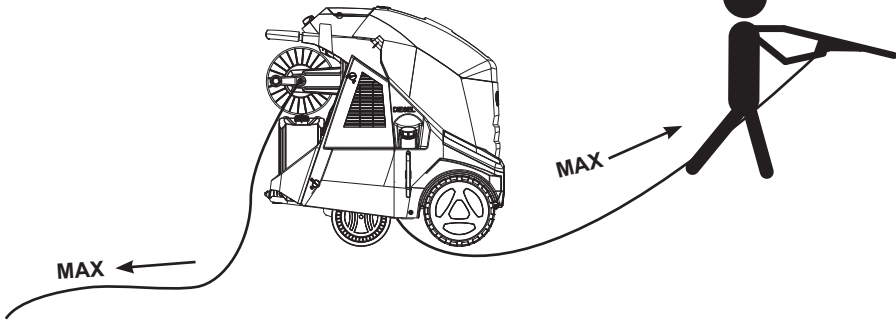

E5

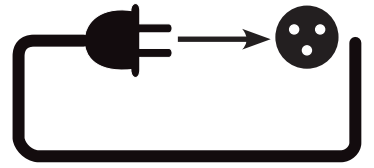

E6

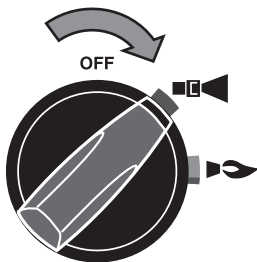

E7

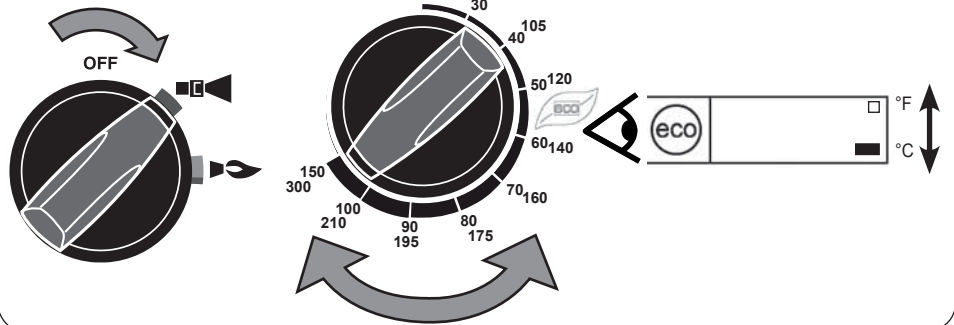

E8

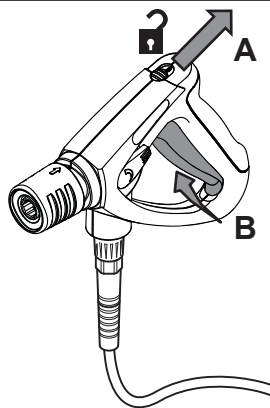
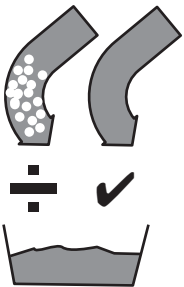

E9

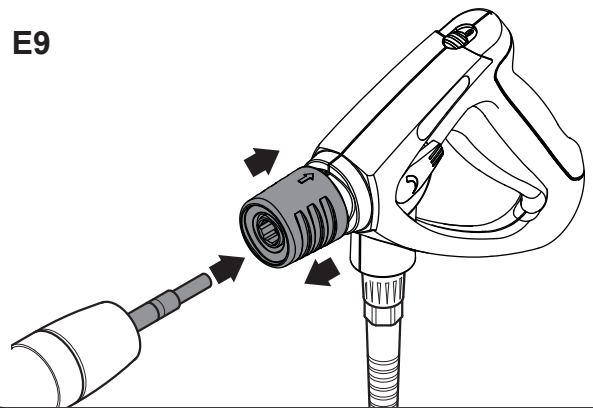

E10.a

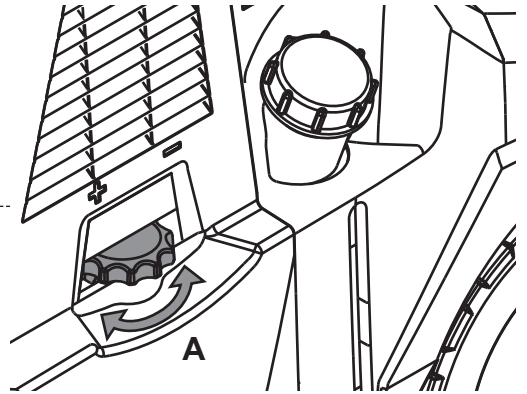
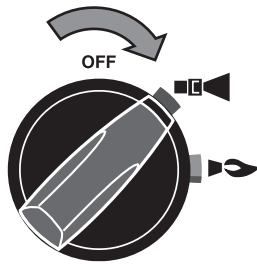

E10.b



Max 100°C/210°F

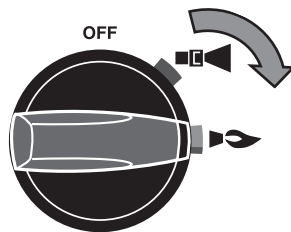
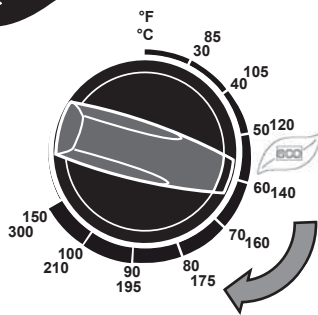

E10.c

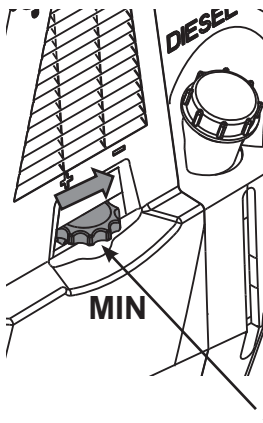
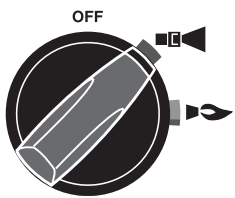

Max 32 bar

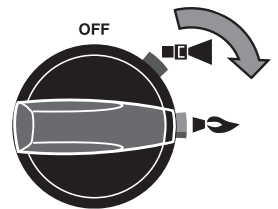
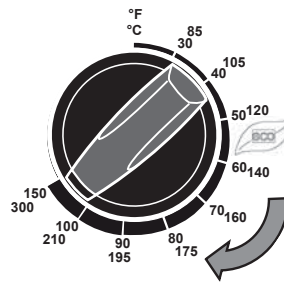

E

E11

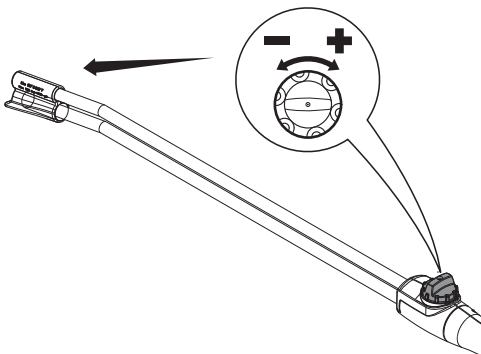
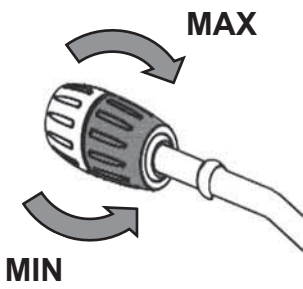
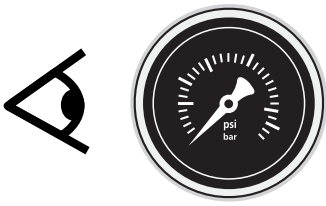

E12

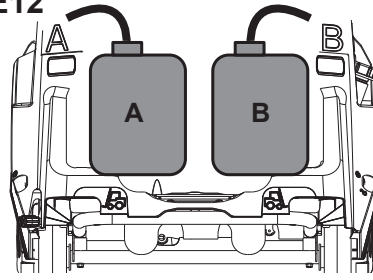

E12.b

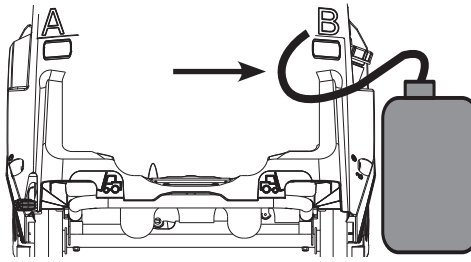

E12.c

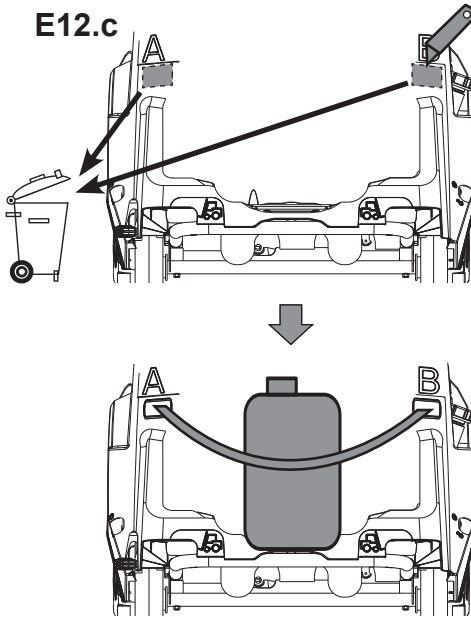

E13

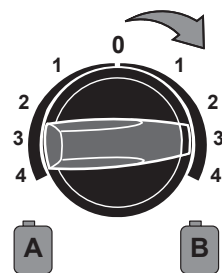
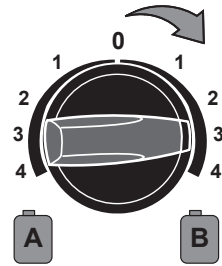
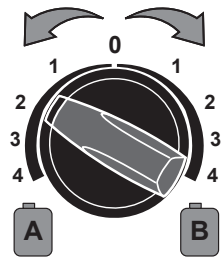

F

F1

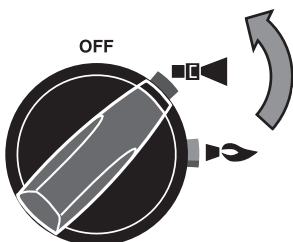

F2

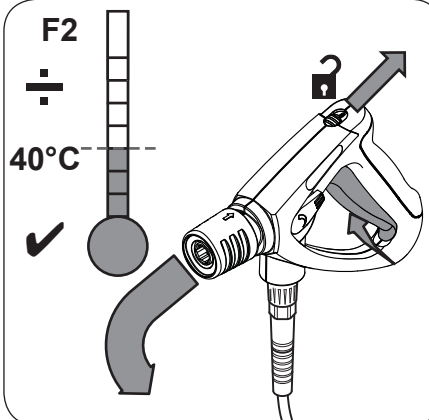

F3

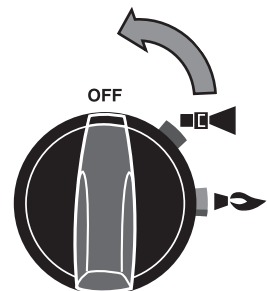



F

F4

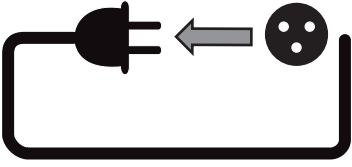

F5

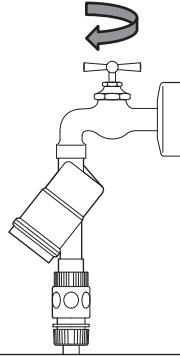

F6

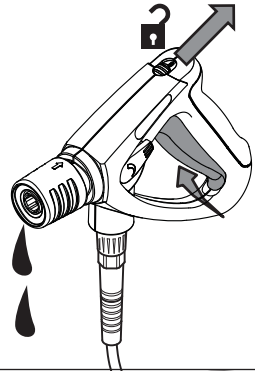

F7

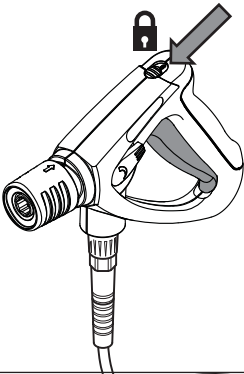

G

G1

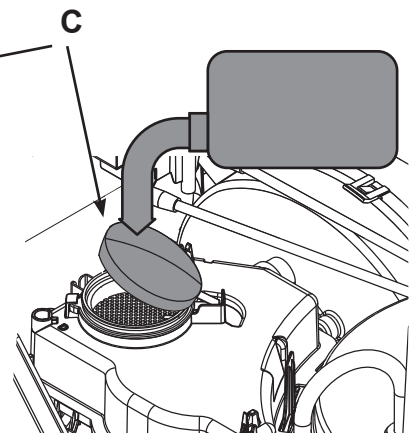
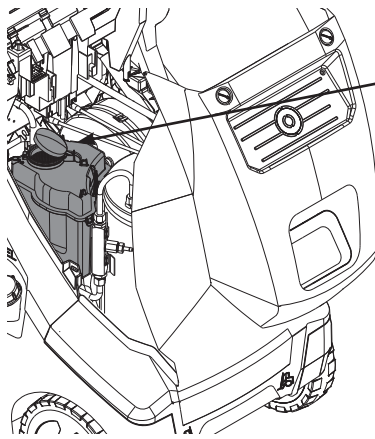
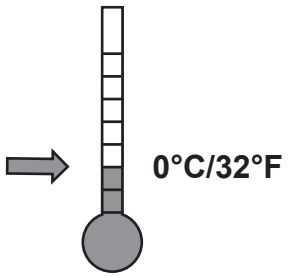

G2

B

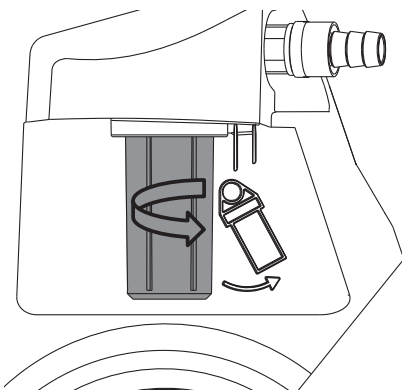

C

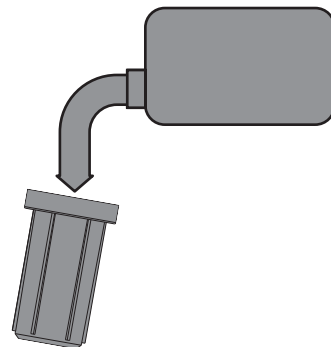

H1.a

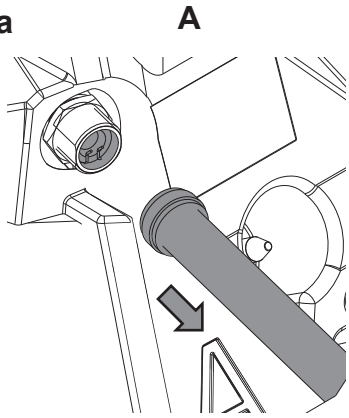

**B**

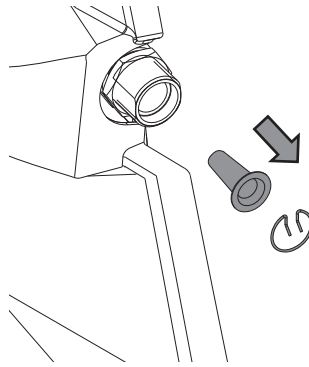

**C**

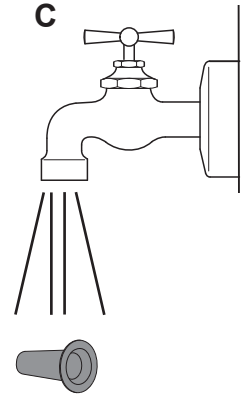

H1.b

**A**

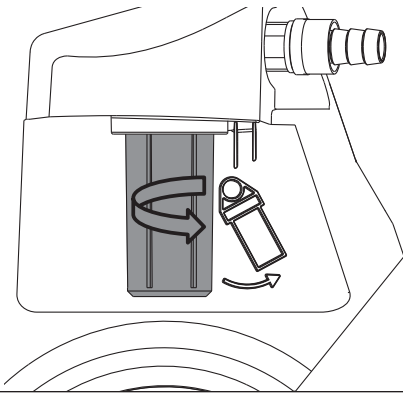

**B**

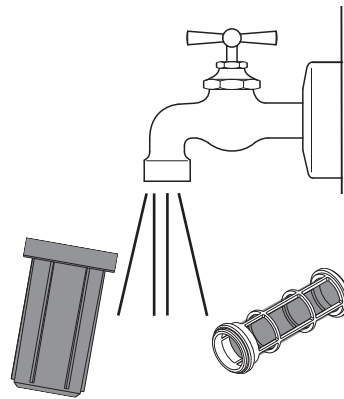

H2

**A**

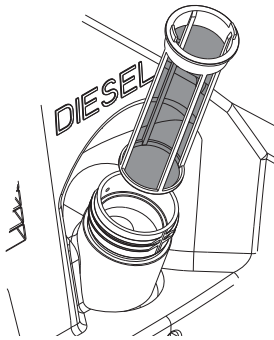

**B**

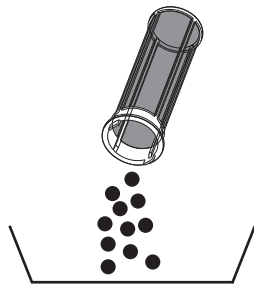

H3

**A**

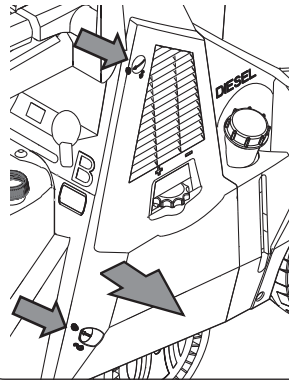

**B**

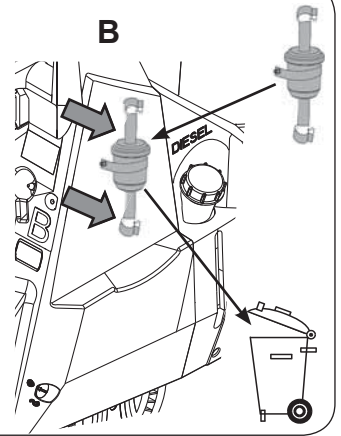

H4

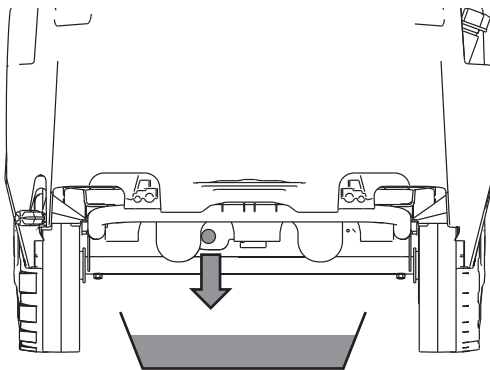

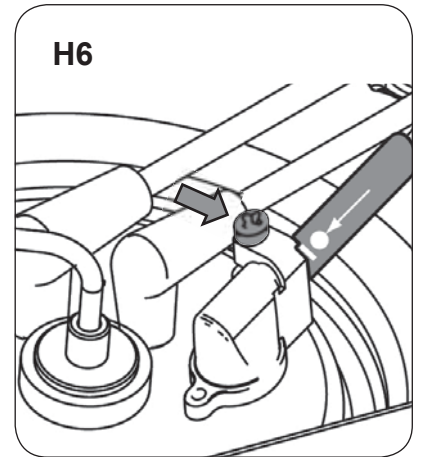
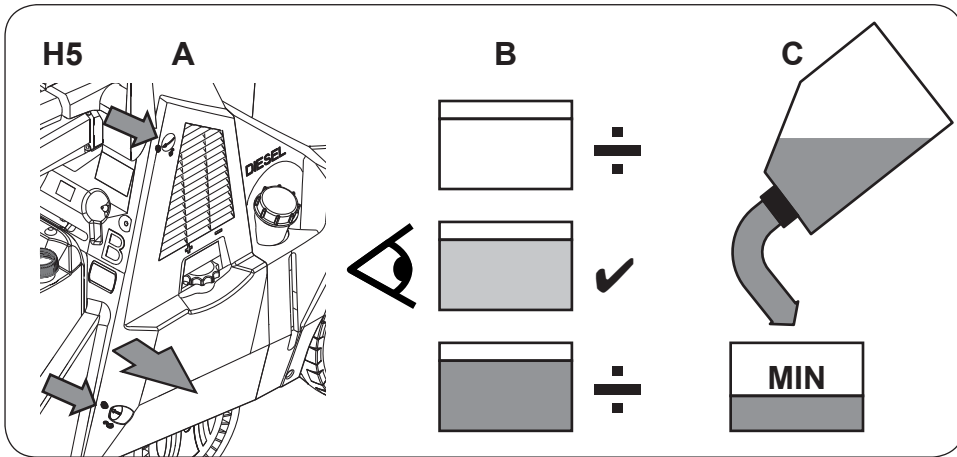

<b>EN</b>	Operating instructions .....	14
<b>DE</b>	Bedienungsanweisungen .....	18
<b>FR</b>	Instructions de fonctionnement .....	22
<b>NL</b>	Gebruiksaanwijzingen .....	26
<b>IT</b>	Istruzioni per l'uso .....	30
<b>NO</b>	Bruksanvisning .....	34
<b>SV</b>	Bruksanvisning .....	38
<b>DA</b>	Betjeningsvejledning .....	42
<b>FI</b>	Käyttöohje .....	46
<b>ES</b>	Instrucciones de funcionamiento .....	50
<b>PT</b>	Instruções de Funcionamento .....	54
<b>EL</b>	Οδηγίες λειτουργίας .....	58
<b>TR</b>	Kullanma Talimatları .....	63
<b>SL</b>	Navodila za delovanje .....	68
<b>HR</b>	Upute za uporabu .....	72
<b>SK</b>	Návod na obsluhu .....	76
<b>CS</b>	Návod k obsluze .....	80
<b>PL</b>	Instrukcje dotyczące obsługi .....	84
<b>HU</b>	Használati útmutató .....	88
<b>RO</b>	Instrucțiuni de utilizare.....	92
<b>BG</b>	Указания за експлоатация .....	96
<b>RU</b>	Руководство по эксплуатации .....	101
<b>ET</b>	Tööjuhised .....	106
<b>LV</b>	Norādījumi par ekspluatāciju .....	110
<b>LT</b>	Naudojimo instrukcija .....	114
<b>JA</b>	作手順.....	118
<b>ZH</b>	操作说明.....	122
<b>KO</b>	사용법.....	126
<b>TH</b>	คำแนะนำการใช้งาน.....	130
<b>MS</b>	Arahan Operasi .....	134

## Instrucciones de funcionamiento

Este limpiador a alta presión se ha diseñado para uso profesional en las siguientes aplicaciones: la agricultura, la industria, la logística, la limpieza de vehículos, las instituciones públicas, la industria de limpieza, la construcción, la industria alimentaria etc.

### Guía rápida de referencia gráfica

La guía rápida de referencia gráfica está diseñada para ayudarle a poner en marcha, operar y almacenar la unidad. La guía se divide en 8 secciones.

#### A

##### Antes de empezar

##### LEA PRIMERO LAS INSTRUCCIONES DE SEGURIDAD

##### Elementos funcionales:

- A1. Bloqueo de la tapa
- A2. Soporte para suspensión de grúa<sup>1)</sup>
- A3. Chimenea caliente
- A4. Gancho del cable
- A5. Bloqueo del carrete de la manguera de alta presión<sup>1)</sup>
- A6. Pistola de aspersión
- A7. Conexión del suministro de agua
- A8. Filtro de la toma de agua<sup>1)</sup>
- A9. Gancho ajustable para cable
- A10. Freno de estacionamiento
- A11. Caja de herramientas
- A12. Tablero de mando
- A13. Conexión de la manguera de alta presión en máquinas sin tambor para manguera B4.a/B4b<sup>1)</sup>
- A14. Carrete de la manguera de alta presión<sup>1)</sup>
- A15. Manivela del tambor de la manguera<sup>1)</sup>
- A16. Lugar para el bote de detergente
- A17. Estribo para inclinar el aparato
- A18. Cargador del depósito de Nilfisk AntiStone
- A19. Gancho de la manguera de alta presión
- A20. Apertura de la puerta lateral
- A21. Etiqueta de advertencia de seguridad
- A22. Tubo de carga de combustible
- A23. Soporte de la pistola rociadora
- A24. Control de regulación del flujo<sup>1)</sup>
- A25. Vista del nivel de combustible
- A26. Manguera larga de detergente para recipiente externo
- A27. Indicador LED de intervalo de mantenimiento
- A28. Indicador LED de nivel bajo de Nilfisk AntiStone<sup>1)</sup>
- A29. Indicador LED de nivel bajo de combustible<sup>1)</sup>
- A30. Indicador LED de nivel bajo de aceite de la bomba 1)
- A31. Indicador LED de encendido
- A32. Manómetro<sup>1)</sup>
- A33. Indicador LED de sobrecalentamiento de la caldera
- A34. Indicador LED de ausencia de llama
- A35. Indicador LED de modo ECO
- A36. Contador de horas; Lectura de la temp.; Códigos de error<sup>1)</sup>
- A37. Indicador Fahrenheit /Celsius<sup>1)</sup>
- A38. Interruptor principal con selección de agua caliente / fría
- A39. Mando de control de temperatura
- A40. Dosificador de detergente<sup>1)</sup>

#### B

##### Desembalaje y preparación de la unidad

- B1. Quitar los elementos de seguridad del limpiador.
- B2. Extraer la manguera, la lanza y el cable del palé.
- B3. Si lo desea, se puede cambiar el carrete de la manguera para manejarlo con la mano izquierda<sup>1)</sup>.
- B4.a Máquinas con carrete de manguera: Retire las tapas de

transporte de la entrada y salida. Conecte la manguera de alta presión, enróllela en el carrete y bloquee el carrete en el mango (A)<sup>1)</sup>.

- B4.b Máquinas sin carrete de manguera: Retire las tapas de transporte de la entrada y salida. Conecte la manguera de alta presión y colóquela en el gancho (B).
- B5. Coloque el cable de alimentación alrededor de los ganchos de los cables (A y B) y fije el extremo del cable en el gancho (B).
- B6. El dispositivo Nilfisk Antiscale se configura en la fábrica para una dureza de agua moderada. Consulte el cuadro de la sección de mantenimiento. La indicación de advertencia se cancela cuando se establece en "0".
- B7. Suelte el freno de la rueda.
- B8. Levante el mango y tire de la rueda trasera del limpiador en el palé hasta el suelo.
- B9. Para facilitar la basculación y la maniobra pise el estribo y empuje el mango hacia abajo.

#### C

##### Elevación y sujeción con correa para el transporte

- C1.a La forma más segura de levantar el limpiador es utilizar una carretilla elevadora desde el extremo frontal o trasero del limpiador. (Nunca desde los lados).
- C1.b Utilice los puntos de fijación (A, B, C) para levantar con correas.  
No tire ni envuelva con correas las piezas de plástico de la máquina ya que podrían desprenderse de la estructura.
- C1.c Por seguridad se recomienda el conjunto de accesorios de elevación Nilfisk (#107140912 + #301001090).
- C2. Utilice los puntos de fijación (A, B, C) para colocar correas de transporte.  
No tire ni envuelva con correas las piezas de plástico de la máquina ya que podrían desprenderse de la estructura.

#### D

##### Preparación de la unidad:

Si la el emplazamiento está a más de 500 m sobre el nivel del mar, el quemador puede requerir un reajuste para optimizar el consumo de combustible. Póngase en contacto con el servicio de asistencia de Nilfisk. Si la altitud es superior a 1000-2500 m podría requerir un kit quemador opcional. Consulte al servicio de asistencia de Nilfisk.

Antes de usar el limpiador por primera vez, compruébelo cuidadosamente para detectar cualquier fallo o daño. Haga funcionar la máquina sólo cuando esté en perfectas condiciones.

- D1. La pendiente en que se instale el limpiador de alta presión no debe exceder en ningún caso los 10° en cualquier dirección. Nota: la temperatura ambiente debe ser mayor de 0 °C y no superar 40 °C.
- D2. Prepare el freno.
- D3. Llene el depósito de detergente<sup>1)</sup>.
- D4. Llene el depósito de Nilfisk AntiStone<sup>1)</sup>.
- D5. Llene el depósito con aceite nuevo, DIN 51603-1 (sin biodiésel). Se puede utilizar diésel según EN 590 (hasta el 7% de biodiésel) con las siguientes restricciones: Tiempo máximo de almacenamiento en el depósito de diésel limpio de alta presión: 1 mes. No use diésel con más de 6 meses. El diésel EN 590 procedente de un recipiente abierto no se debe utilizar. Puede ver el nivel de combustible (A) a través de la ventana bajo el punto de llenado.





#### E

##### Encender la unidad

OBS: La máquina puede estar protegida con un líquido anticon-



gelante de la fábrica<sup>1)</sup> Tenga en cuenta el punto E8 más adelante.

- E1. Conecte el suministro de agua.
- E2. Compruebe si tiene la etiqueta de seguridad tiene el icono . Si es así se requiere una válvula antirretorno.
- E3. Gire el gancho y retire el cable.
- E4. Desenrolle la manguera y el cable en toda su longitud antes de su uso.
- E5. Conecte la fuente de alimentación.
- E6. Encienda el limpiador. Funcionamiento con agua fría.
- E7. Establecer Fahrenheit / Celsius: (A) encendiendo o apagando en el modo frío y (B) poniendo el control de temperatura al máximo<sup>1)</sup>.
- E8. Suelte el bloqueo de seguridad y expulse el aire de la máquina activando la pistola de pulverización. Si la máquina tiene anticongelante, extraiga 5 litros en un contenedor para su reutilización. Cuando se establezca el flujo de agua, continúe con los siguientes pasos.
- E9. Conecte la lanza a la pistola pulverizadora.
- E10.a Ajuste del modo de agua fría.  
Ponga el limpiador en modo .  
La regulación del flujo se ajusta en el mango de la bomba (A).
- E10.b Modo de agua caliente (hasta 100 °C)  
Seleccione la temperatura y el modo ECO para una limpieza estándar óptima.  
Ponga el limpiador en modo .  
La regulación del flujo se ajusta en el mango de la bomba (A).
- E10.c Modo de vapor<sup>1)</sup> (más de 100 °C)  
Gire el regulador del flujo<sup>1)</sup> (A) totalmente hacia la derecha hasta el final  
(Nota: máx. 32 bar para temperaturas superiores a 100 °C).  
Seleccione una temperatura por encima de 100 °C.  
Ponga el limpiador en modo .
- E11. Regule la presión en FlexoPower o Tornado Lance<sup>1)</sup>.
- E12.a Succión desde el depósito de detergente interno.  
Establezca la concentración deseada del agente de limpieza (A) o (B) con el dosificador<sup>1)</sup>.
- E12.b Succión desde un depósito de detergente externo:  
Tire de la manguera (B) desde el chasis y conéctela al depósito. Establezca la concentración deseada del agente de limpieza (A) o (B) con el dosificador<sup>1)</sup>.
- E12.c Succión desde un depósito de 25 l: (sólo para la versión sin carrete de manguera). Corte el área marcada con un cuchillo para abrir los puntos de envoltura. Envuelva el depósito a la parte posterior de la máquina. Tire de la manguera (B) desde el chasis y conéctela al depósito.
- E13. Uso de agentes de limpieza: Establezca la concentración deseada del agente de limpieza (A) o (B) con el dosificador<sup>1)</sup>.  
Pulverice el objeto. Deje que actúe el producto de limpieza según el grado de suciedad. A continuación enjuague con el chorro de rociado de alta presión. No permita que el agente limpiador se seque ya que la superficie se puede dañar.

## F

### Después de usar la unidad o antes de dejarla sin supervisión

- F1. Póngala en modo frío.
- F2. Hágala funcionar en modo frío para enfriarla.
- F3. Apague el limpiador. Ponga el interruptor en posición "OFF".
- F4. Desconecte la alimentación.
- F5. Cierre el grifo del agua.

- F6. Apriete la pistola pulverizadora para liberar la presión.
- F7. Coloque el cierre de seguridad de la pistola pulverizadora.

## G

- G1. **Almacenar el limpiador (a menos de 0 °C):**  
Retire la manguera de entrada de agua del limpiador. Desmonte la lanza de aspersión. Conecte el limpiador con el interruptor principal en la posición (agua fría). Accione la pistola. Poco a poco, introduzca anticongelante (aprox. 5 litros) en el depósito de agua (C). La máquina estará protegida contra la congelación cuando la solución de anti-congelante salga por la boquilla de la pistola. Bloquee el seguro de la pistola. Apague la máquina. Para evitar riesgos, guarde el aparato temporalmente en una dependencia caliente antes de usarlo. Cuando vuelva a utilizar la máquina, tendrá que retirar la solución de anti-congelante y guardarla para usar en el futuro.
- G2. Incline y desenrosque el filtro de cristal<sup>1)</sup>, vacíelo de agua, llénelo con anticongelante y vuelva a colocarlo en el limpiador.

## H

### Mantenimiento y resolución de problemas

- H1.a Toma de agua - filtro de la toma<sup>1)</sup>: Desatornille el acoplamiento rápido. Quite el bloqueo y el filtro, y límpielo con agua.
- H1.b Filtro de agua – Filtro grande<sup>1)</sup>: Incline el cristal hacia el exterior, desenrósquelo y límpielo con agua.
- H2. Filtro de llenado de combustible: El filtro se puede quitar con los dedos y aclararse con combustible limpio.
- H3. Filtro de combustible: Abra la puerta lateral de acceso (A). Abra las abrazaderas de la manguera y reemplace el filtro de combustible (B). Observe las normas vigentes. Póngase en contacto con Nilfisk para solicitar filtros de recambio.
- H4. Depósito de combustible: Quite el tapón de drenaje y vacíe el combustible en un recipiente vacío. Enjuague con combustible limpio. Observe las normas vigentes.
- H5. Aceite de la bomba: Comprobación de la calidad del aceite de la bomba: Compruebe el color del aceite de la bomba. Si el aceite tiene color gris oscuro o blanco, póngase en contacto con el servicio técnico de Nilfisk. Rellene la bomba de frío con aceite nuevo hasta la marca MAX si es necesario.
- H6. Sensor de llama<sup>1)</sup>: Desmonte el sensor y límpielo con un paño suave. Asegúrese de que el sensor se acopla correctamente al volver a instalarlo, con los símbolos hacia arriba.

Indicaciones en pantalla

Luces indicadoras	Mostrar <sup>1)</sup>	Causa	Solución
Fijo	0024	- El dispositivo está listo para su uso. - Al encender en modo frío, el contador de horas se muestra durante unos segundos.	
Intermitente		- Grifo de agua cerrado o falta de agua. - Depósito de detergente vacío. - La regulación de presión en los módulos de control de seguridad o la lanza VarioPress <sup>1)</sup> se han ajustado con un volumen de agua bajo. - La máquina tiene una acumulación calcárea.	- Compruebe el suministro de agua. - Reponga el detergente o ajuste el valor en "0". - Cambie el ajuste en el bloque de control de seguridad / VarioPress para permitir el flujo de agua completo. -  Nilfisk Service.
Intermitente	FLO	- La máquina lleva más de 120 s sin suministro de agua adecuado. La máquina se apaga para evitar el sobrecalentamiento de la bomba.	- Reinicie la máquina, si el fallo continúa Nilfisk Service.
Fijo	FUE	- Bajo nivel de combustible. - Es posible hacer funcionar la máquina con agua fría.	- Compruebe el nivel de combustible y recarga, el error se restablece después de 5 s.
Fijo		- Nivel bajo de Nilfisk AntiStone <sup>1)</sup> . - La máquina sigue funcionando.	- Compruebe el nivel de Nilfisk AntiStone y rellene si es preciso.
Fijo  Fijo		- El intervalo de mantenimiento se ha sobrepasado. - La máquina sigue funcionando.	-  Nilfisk Service.
Fijo  Intermitente		- Quedan 20 horas para el intervalo de mantenimiento. - La máquina sigue funcionando.	-  Nilfisk Service.
Fijo	HOS	- Sobrecalentamiento del calentador. El sensor de salida (EXT-H) ha interrumpido el suministro de combustible. - La máquina tiene una acumulación calcárea. - No se ha realizado mantenimiento en el calentador. - Es posible hacer funcionar la máquina con agua fría.	-  Nilfisk Service.
Fijo  Fijo	LHE	- El sensor de la llama (B7) está cubierto de hollín. - Fallo del sistema de combustible o ignición. - Es posible hacer funcionar la máquina con agua fría.	- Limpie el sensor de la llama (B7). -  Nilfisk Service.
Intermitente Intermitente	LHL	- El calentador se ha sobrecalentado y necesita mantenimiento. - El calentador está lleno de diésel.	-  Nilfisk Service.
Fijo  Fijo	HOP	- Sobrecalentamiento del motor.	- Coloque el interruptor principal en la posición "OFF" y deje que la máquina se enfríe - Quite/desmonte el cable de extensión. - Posible fallo de fase. - Compruebe la conexión eléctrica. -  Nilfisk Service.
Fijo  Intermitente Intermitente	SEC SEO	- Cortocircuito del sensor de temperatura. - El sensor de temperatura está desconectado. - Es posible hacer funcionar la máquina con agua fría.	-  Nilfisk Service.
Fijo  Fijo	FLF	- Fallo del sensor de flujo.	-  Nilfisk Service.
Fijo	POL	- Aceite de la bomba bajo. - Fuga de aceite en la MPU.	- Compruebe el nivel de aceite y rellene si es necesario. -  Nilfisk Service.

## Otros fallos

Fejl	Causa	Subsanación
no se ilumina	- Enchufe de red sin acoplar.	- Acoplar el enchufe de red. - Verificar suficiente seguros (véase apartado Características).
Presión demasiado baja	- Tobera de alta presión desgastada. - Regulación de la presión o dispositivo VarioPress <sup>1)</sup> ajustado a volumen demasiado pequeño <sup>1)</sup> .	- Renovar tobera de alta presión. - Girar la regulación de la presión en el bloque de seguridad de regulación en dirección "+", o bien ajustar el botón giratorio VarioPress <sup>1)</sup> en la pistola a un mayor volumen de agua (véase apartado E10-11).
Agente de limpieza no llega	- Depósito de agente de limpieza vacío. - Depósito de agente de limpieza embarrado. - Válvula de aspiración en la manguera de aspiración de agente de limpieza sucia.	- Rellenar depósito agente de limpieza. - Limpiar depósito de agente de limpieza. - Desmontar y limpiar la válvula de aspiración.
El quemador está cubierto de hollín	- Combustible sucio. - Quemador sucio o no ajustado correctamente.	-  Nilfisk Service.

## B6. Ajuste anticalcáreo

1. Abra el bastidor (A). Mida la dureza del agua o pregunte a su empresa de suministro de agua.						2. Ajuste el mando (B) según el flujo de agua nominal				
mg/l	Grano	°dH	°e	°f	ppm Ca	Descripción	9-15 L/min	16-20 L/min	21-26 L/min	27-33 L/min
0-17	0-1	0-7	0-8,8	0-12,5	0-50	Suave	0	0	0	0
17-60	1,1-3,5					Un poco dura	0,5	1	2	2
60-128	3,6-7,5	7-14	8,8-17,5	12,5-25,1	51-150	Moderadamente dura	1	1,5	2,5	3
128-180	7,6-10,5	14-21	17,5-26,3	25,1-37,6	151-300	Dura	1,5	2	3	3,5
>180	>10,5	>21	>26,3	>37,6	>300	Muy dura	2	3	3,5	4

## Plan de mantenimiento

	Semanalmente	Según sea necesario	Después de las primeras 50 horas de funcionamiento	Cuando se encienda el indicador de mantenimiento
Filtros de agua		●		
Compruebe y limpie el filtro de combustible de la entrada del depósito		●		
Compruebe y sustituya el filtro de combustible interno		●		
Limpie el depósito de combustible		●		
Engrase las boquillas de acoplamiento rápido para la manguera, la pistola y la lanza	●			
Compruebe la calidad del aceite de la bomba	●			
Cambie el aceite de la bomba			Nilfisk Service	Nilfisk Service

### Declaración de conformidad UE

Nosotros,  
Nilfisk A/S, Kornmarksvej 1, DK-2605 Broendby, DINAMARCA

Declaramos que los  
Productos: HPW - Professional – Mobile Hot  
Descripción: 230V, 400-460V, 1~, 3~, 50 Hz, IPX5  
Tipo: MH 3M, MH 4M, MH 5M, MH 6P, MH 7P





















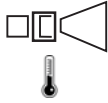

Cumplen las siguientes normas:  
EN 60335-1:2012+A11:2014  
EN 60335-2-79:2012  
EN 55014-1:2006+A1:2009+A2:2011  
EN 55014-2:2015  
EN 61000-3-2:2014  
EN 61000-3-11:2000

Siguiendo las disposiciones de:  
Directiva sobre maquinaria 2006/42/CE  
Directiva sobre EMC 2014/30/CE  
Directiva sobre emisión de ruido 2000/14/CE – Procedimiento de evaluación de la conformidad de acuerdo con el Anexo V.  
- Nivel de ruido medido: 72-76 dB(A);  
- Nivel de ruido garantizado: 88-92 dB(A)





















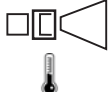

Hadsund, 28-09-2016

Anton Sørensen  
Senior Vice President, Global R&D

## Specifications



















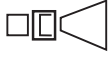
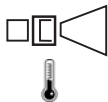

			MH 3M-140/580 PA	MH 3M-100/600 PA	MH 3M-160/770 PA	MH 3M-160/770 PAX	MH 4M-100/680 PA	
1			EU	GB	EU	NO	GB	
2		V/ph/Hz	230/1/50	230/1/50	400/3/50	230/400/3/50	230/1/50	
3		A	C 16	C 13	C 16	C 25/16	C 13	
4		kW кВт	3.6	2.8	4.7	4.7	2.9	
5		A	16	12.5	8	14/8	13	
6		bar Бар 巴	140	100	160	160	100	
7		l/min л/мин 升/分钟	9.70	10.00	11.70	11.70	10.50	
8		bar Бар 巴	210	150	240	240	150	
9		l/min	9.70	10.00	12.80	12.80	11.30	
10			NT 0370	NT 0450	NT 0400	NT 0400	NT 0475	
11		°C	80/-	80/-	80/-	80/-	90/150	
12		°C	40					
13		bar Бар 巴	10					
14		mm 毫米	1010/700/1016					
15		kg кг	114	114	133	136	138	
16	 $K_{PA} = 3 \text{ dB}$	dB(A) дБ(A)	75.0	75.0	76.0	76.0	72.0	
17	 $K_{WA} = 3 \text{ dB}$	dB(A) дБ(A)	91.0	91.0	92.0	92.0	88.0	
18	 (ISO 5349 a <sub>v</sub> )	m/s <sup>2</sup> 米/秒 <sup>2</sup>	2.8 ±1	2.7 ±1	2.9 ±1	2.9 ±1	2.7 ±1	
19		N	23.70	20.70	29.50	29.50	20.30	
20		L л 升	0.39 / SAE 80W-90	0.39 / SAE 80W-90	0.39 / SAE 80W-90	0.39 / SAE 80W-90	0.75 / Castrol Alphasyn T 150	
21		kW кВт	42	42	55	55	70	
22		L/л/升	15					
23		L/л/升	B: 10 L	B: 10 L	B: 10 L	B: 10 L	A: 10 L B: +	

## Specifications





















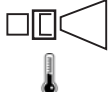

			MH 4M- 100/680 PAX	MH 4M- 210/1000 PAX	MH 4M- 130/720 FA	MH 4M- 180/860 FAL	MH 4M- 180/860 FA
1			GB	EU	EU	EU	EU
2		V/ph/Hz	230/1/50	400/3/50	230/1/50	400/3/50	400/3/50
3		A	C 13	C 16	C 16	C 16	C 16
4		kW кВт	2.9	8.0	3.6	5.9	5.9
5		A	13	13.5	16	10	10
6		bar Бар 巴	100	210	130	180	180
7		l/min л/мин 升/分钟	10.50	15.70	11.00	13.20	13.20
8		bar Бар 巴	150	250	195	250	250
9		l/min	11.30	16.70	12.00	14.30	14.30
10			NT 0475	NT 0475	NT 0435	NT 0435	NT 0435
11		°C	90/150	90/150	90/150	90/150	90/150
12		°C	40				
13		bar Бар 巴	10				
14		mm 毫米	1010/700/1016				
15		kg кг	141	149	141	133	133
16	 K <sub>PA</sub> = 3 dB	dB(A) дБ(A)	72.0	76.0	73.0	75.0	75.0
17	 K <sub>WA</sub> = 3 dB	dB(A) дБ(A)	88.0	92.0	89.0	91.0	91.0
18	 (ISO 5349 a <sub>v</sub> )	m/s <sup>2</sup> 米/秒 <sup>2</sup>	2.7 ±1	3.3 ±1	2.8 ±1	3.1 ±1	3.1 ±1
19		N	20.50	46.70	25.40	35.40	35.40
20		L л 升	0.75 / Castrol Alphasyn T 150	0.75 / Castrol Alphasyn T 150	0.75 / Castrol Alphasyn T 150	0.75 / Castrol Alphasyn T 150	0.75 / Castrol Alphasyn T 150
21		kW кВт	70	70	55	70	70
22		L/л/升	15				
23		L/л/升	A: 10 L B: +	A: 10 L B: +	A: 10 L B: +	B: 10 L	A: 10 L B: +























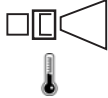

## Specifications

			MH 4M-180/890 FA	MH 4M-180/890 FA	MH 4M-200/960 FA	MH 4M-200/960 FA	MH 4M-200/960 FAX
1			JP	JP	EU	NO	EU
2		V/ph/Hz	200/3/50	200/3/60	400/3/50	230/400/3/50	400/3/50
3		A	C 20	C 20	C 16	C 25/16	C 16
4		kW кВт	5.9	5.9	7.2	7.2	7.2
5		A	20	20	12	21/12	12
6		bar Бар 巴	180	180	200	200	200
7		l/min л/мин 升/分钟	13.80	13.80	14.80	14.80	14.80
8		bar Бар 巴	250	250	250	250	250
9		l/min	14.80	14.80	16.00	16.00	16.00
10			NT 0475	NT 0475	NT 0475	NT 0475	NT 0475
11		°C	90/150	90/150	90/150	90/150	90/150
12		°C	40				
13		bar Бар 巴	10				
14		mm 毫米	1010/700/1016				
15		kg кг	133	133	142	144	142
16		dB(A) дБ(A)	75.0	75.0	76.0	76.0	76.0
17		dB(A) дБ(A)	91.0	91.0	92.0	92.0	92.0
18		m/s <sup>2</sup> 米/秒 <sup>2</sup>	3.1 ±1	3.2 ±1	3.2 ±1	3.2 ±1	3.2 ±1
19		N	38.50	40.30	42.80	42.80	43.30
20		L л 升	0.75 / Castrol Alphasyn T 150	0.75 / Castrol Alphasyn T 150	0.75 / Castrol Alphasyn T 150	0.75 / Castrol Alphasyn T 150	0.75 / Castrol Alphasyn T 150
21		kW кВт	70	70	70	70	70
22		L/л/升	15				
23		L/л/升	A: 10 L B: +	A: 10 L B: +	A: 10 L B: +	A: 10 L B: +	A: 10 L B: +



















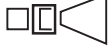
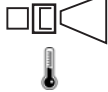

## Specifications

			MH 4M- 200/960 FAX	MH 4M- 200/960 FA	MH 4M- 220/1000 FA	MH4M- 220/1000 FAXT
1			NO	EXP	EU	EU
2		V/ph/Hz	230/400/3/50	220-230/440- 460/3/60	400/3/50	400/3/50
3		A	C 25/16	C 25/16	C 16	C 16
4		kW кВт	7.2	7.2	7.2	7.2
5		A	21/12	21/12	14	14
6		bar Бар 巴	200	200	220	220
7		l/min л/мин 升/分钟	14.80	14.80	15.70	15.70
8		bar Бар 巴	250	250	250	250
9		l/min	16.00	16.00	16.70	16.70
10			NT 0475	NT 0475	NT 0475	NT 0475
11		°C	90/150	90/150	90/150	90/150
12		°C	40			
13		bar Бар 巴	10			
14		mm 毫米	1010/700/1016			
15		kg кг	147	142	142	149
16	 K <sub>PA</sub> = 3 dB	dB(A) дБ(A)	76.0	76.0	76.0	76.0
17	 K <sub>WA</sub> = 3 dB	dB(A) дБ(A)	92.0	92.0	92.0	92.0
18	 (ISO 5349 a <sub>v</sub> )	m/s <sup>2</sup> 米/秒 <sup>2</sup>	3.2 ±1	3.2 ±1	3.4 ±1	3.4 ±1
19		N	43.30	42.90	47.20	47.30
20		L л 升	0.75 / Castrol Alphasyn T 150	0.75 / Castrol Alphasyn T 150	0.75 / Castrol Alphasyn T 150	0.75 / Castrol Alphasyn T 150
21		kW кВт	70	70	70	70
22		L/л/升	15			
23		L/л/升	A: 10 L B: +	A: 10 L B: +	A: 10 L B: +	A: 10 L B: +



















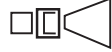
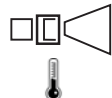

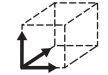
## Specifications

			MH 5M-100/760 PA UK	MH 5M-100/760 PAX UK	MH 5M-200/960 FA	MH 5M-200/960 FAX	MH 5M-210/1100 FA	
1			GB	GB	EU	EU	EU	
2		V/ph/Hz	230/1/50	230/1/50	400/3/50	400/3/50	400/3/50	
3		A	C 13	C 13	C 16	C 16	C 16	
4		kW кВт	2.9	2.9	7.2	7.2	7.9	
5		A	13	13	12	12	13.5	
6		bar Бар 巴	100	100	200	200	210	
7		l/min л/мин 升/分钟	11.30	11.30	14.80	14.80	17.50	
8		bar Бар 巴	150	150	250	250	250	
9		l/min	12.70	12.70	16.00	16.00	18.30	
10			NT 0500	NT 0500	NT 0475	NT 0475	NT 0550	
11		°C	90/150	90/150	90/150	90/150	90/150	
12		°C	40					
13		bar Бар 巴	10					
14		mm 毫米	1188/ 700/ 1020					
15		kg кг	167	170	174	171	174	
16	 $K_{PA} = 3 \text{ dB}$	dB(A) дБ(A)	73.3	73.3	75.3	75.3	76.9	
17	 $K_{WA} = 3 \text{ dB}$	dB(A) дБ(A)	88.4	88.4	90.4	90.4	92.0	
18	 (ISO 5349 a <sub>v</sub> )	m/s <sup>2</sup> 米/秒 <sup>2</sup>	2.0 ±1	2.0 ±1	2.0 ±1	2.0 ±1	2.0 ±1	
19		N	23.60	23.80	42.70	43.20	52.80	
20		L л 升	0.75 / Castrol Alphasyn T 150	0.75 / Castrol Alphasyn T 150	0.75 / Castrol Alphasyn T 150	0.75 / Castrol Alphasyn T 150	0.75 / Castrol Alphasyn T 150	
21		kW кВт	70	70	80	80	90	
22		L/л/升	30					
23		L/л/升	A: 10 L B: 10 L	A: 10 L B: 10 L	A: 10 L B: 10 L	A: 10 L B: 10 L	A: 10 L B: 10 L	

## Specifications



















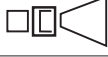
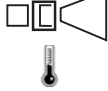

			MH 5M-210/1100 FAX	MH 5M-210/1100 FA	MH 5M-210/1100 FAX	MH 5M-210/1100 PAX	MH 5M-210/1100 FA
1			EU	NO	NO	EU	EXP
2		V/ph/Hz	400/3/50	230/400/3/50	230/400/3/50	400/3/50	220-230/440-460/3/60
3		A	C 16	C 25/16	C 25/16	C 16	C 25/16
4		kW кВт	7.9	7.9	7.9	7.9	7.9
5		A	13.5	24/13.5	24/13.5	13.5	24/13.5
6		bar Бар 巴	210	210	210	210	210
7		l/min л/мин 升/分钟	17.50	17.50	17.50	17.50	17.50
8		bar Бар 巴	250	250	250	250	250
9		l/min	18.30	18.30	18.30	18.30	18.30
10			NT 0550	NT 0550	NT 0550	NT 0550	NT 0550
11		°C	90/150	90/150	90/150	90/150	90/150
12		°C	40				
13		bar Бар 巴	10				
14		mm 毫米	1188/ 700/ 1020				
15		kg кг	179	174	180	179	180
16	 $K_{PA} = 3 \text{ dB}$	dB(A) дБ(A)	76.9	76.9	76.9	76.9	76.9
17	 $K_{WA} = 3 \text{ dB}$	dB(A) дБ(A)	92.0	92.0	92.0	92.0	92.0
18	 (ISO 5349 a <sub>v</sub> )	m/s <sup>2</sup> 米/秒 <sup>2</sup>	2.0 ±1	2.0 ±1	2.0 ±1	2.0 ±1	2.0 ±1
19		N	53.60	52.80	53.60	52.40	52.80
20		L л 升	0.75 / Castrol Alphasyn T 150	0.75 / Castrol Alphasyn T 150	0.75 / Castrol Alphasyn T 150	0.75 / Castrol Alphasyn T 150	0.75 / Castrol Alphasyn T 150
21		kW кВт	90	90	90	90	90
22		L/л/升	30				
23		L/л/升	A: 10 L B: 10 L	A: 10 L B: 10 L	A: 10 L B: 10 L	A: 10 L B: 10 L	A: 10 L B: 10 L

## Specifications



















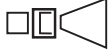
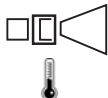

			MH 6P-210/1100 FA	MH 6P-210/1100 FA	MH 6P-175/1250 FA EU	MH 6P-175/1250 FAX EU	MH 6P-200/1300 FA	
1			JP	JP	EU	EU	EU	
2		V/ph/Hz	200/3/50	200/3/60	400/3/50	400/3/50	400/3/50	
3		A	C 30	C 30	C 16	C 16	C 16	
4		kW кВт	8.8	8.7	8.5	8.5	9.1	
5		A	29	28	14.5	14.5	15.5	
6		bar Бар 巴	210	210	175	175	200	
7		l/min л/мин 升/分钟	17.50	17.50	19.20	19.20	20.00	
8		bar Бар 巴	250	250	250	250	250	
9		l/min	18.30	18.30	20.80	20.80	21.70	
10			NT 0550	NT 0550	NT 0750	NT 0750	NT 0680	
11		°C	90/150	90/150	90/150	90/150	90/150	
12		°C	40					
13		bar Бар 巴	10					
14		mm 毫米	1188/ 700/ 1020	1188/ 700/ 1020	1188/ 700/ 1020	1188/ 700/ 1020	1188/ 700/ 1045	
15		kg кг	179	179	180	188	198	
16	 $K_{PA} = 3 \text{ dB}$	dB(A) дБ(A)	76.9	76.9	78.8	78.8	78.8	
17	 $K_{WA} = 3 \text{ dB}$	dB(A) дБ(A)	92.0	92.0	91.2	91.2	92.2	
18	 (ISO 5349 a <sub>v</sub> )	m/s <sup>2</sup> 米/秒 <sup>2</sup>	2.6 ±1	2.6 ±1	2.6 ±1	2.6 ±1	2.6 ±1	
19		N	52.80	52.80	55.40	56.60	59.50	
20		L л 升	0.95 / Castrol Alphasyn T 150	0.95 / Castrol Alphasyn T 150	0.95 / Castrol Alphasyn T 150	0.95 / Castrol Alphasyn T 150	0.95 / Castrol Alphasyn T 150	
21		kW кВт	90	90	90	90	115	
22		L/л/升	30					
23		L/л/升	A: 10 L B: 10 L	A: 10 L B: 10 L	A: 10 L B: 10 L	A: 10 L B: 10 L	A: 10 L B: 10 L	



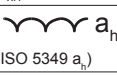









## Specifications





			MH 6P- 200/1300 FA	MH 6P- 200/1300 FAX	MH 6P- 195/1350 FA EXPT	MH 7P- 180/1260 FA	MH 7P- 180/1260 FA
1			NO	EU	EXP	EU	NO
2		V/ph/Hz	230/400/3/50	400/3/50	220-230/440- 460/400/ 3/60	400/3/50	230/400/3/60
3		A	C 25/16	C 16	C 25/16	C 16	C 25/16
4		kW кВт	9.1	9.2	9.2	7.6	7.7
5		A	25/14	15.7	25/13	13.5	24/14
6		bar Бар 巴	200	200	195	180	180
7		l/min л/мин 升/分钟	20.00	20.00	20. 80	19.50	19.50
8		bar Бар 巴	250	250	250	250	250
9		l/min	21.70	21.70	22.50	21.00	21.00
10			NT 0680	NT 0680	NT 0700	NT 0680	NT 0680
11		°C	90/150	90/150	90/150	90/150	90/150
12		°C	40				
13		bar Бар 巴	10				
14		mm 毫米	1188/ 700/ 1045	1188/ 700/ 1045	1188/ 700/ 1045	1188/ 700/ 1045	1188/ 700/ 1045
15		kg кг	207	207	216	195	199
16	 K <sub>PA</sub> = 3 dB	dB(A) дБ(А)	78.8	78.8	78.8	76.5	76.5
17	 K <sub>WA</sub> = 3 dB	dB(A) дБ(А)	92.2	92.2	92.2	91.6	91.6
18	 (ISO 5349 a <sub>h</sub> )	m/s <sup>2</sup> 米/秒 <sup>2</sup>	2.6 ±1	2.6 ±1	2.6 ±1	3.4 ±1	3.4 ±1
19		N	59.70	60.20	61.20	55.40	55.40
20		L л 升	0.95 / Castrol Alphasyn T 150	0.95 / Castrol Alphasyn T 150	0.95 / Castrol Alphasyn T 150	1.10 / Castrol Alphasyn T 150	1.10 / Castrol Alphasyn T 150
21		kW кВт	115	115	115	115	115
22		L/л/升	30				
23		L/л/升	A: 10 L B: 10 L	A: 10 L B: 10 L	A: 10 L B: 10 L	A: 10 L B: 10 L	A: 10 L B: 10 L

## Specifications

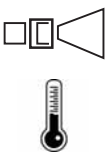





			MH 7P-180/1260 FAX	MH 7P-180/1260 FAX	MH 7P-180/1260 FA	MH 7P-180/1260 FA
1			EU	NO	JP	JP
2		V/ph/Hz	400/3/50	230/400/3/50	200/3/50	200/3/60
3		A	C 16	C 25/16	C 20	C 20
4		kW кВт	7.6	7.7	7.7	7.3
5		A	13.5	25/14.5	27.5	27.5
6		bar Бар 巴	180	180	180	180
7		l/min л/мин 升/分钟	19.50	19.50	19.50	19.50
8		bar Бар 巴	250	250	250	250
9		l/min	21.00	21.00	21.00	21.00
10			NT 0680	NT 0680	NT 0680	NT 0680
11		°C	90/150	90/150	90/150	90/150
12		°C	40			
13		bar Бар 巴	10			
14		mm 毫米	1188/ 700/ 1045	1188/ 700/ 1045	1188/ 700/ 1045	1188/ 700/ 1045
15		kg кг	204	208	195	195
16	 $K_{PA} = 3 \text{ dB}$	dB(A) дБ(A)	76.5	76.5	76.5	76.5
17	 $K_{WA} = 3 \text{ dB}$	dB(A) дБ(A)	91.6	91.6	91.6	91.6
18	 (ISO 5349 a <sub>v</sub> )	m/s <sup>2</sup> 米/秒 <sup>2</sup>	3.4 ±1	3.4 ±1	3.4 ±1	3.4 ±1
19		N	56.00	56.00	55.80	55.20
20		L л 升	1.10 / Castrol Alphasyn T 150	1.10 / Castrol Alphasyn T 150	1.10 / Castrol Alphasyn T 150	1.10 / Castrol Alphasyn T 150
21		kW кВт	115	115	115	115
22		L/л/升	30			
23		L/л/升	A: 10 L B: 10 L	A: 10 L B: 10 L	A: 10 L B: 10 L	A: 10 L B: 10 L



1			<b>EN:</b> Country variant. <b>DE:</b> Ländervarianten. <b>FR:</b> Selon le pays. <b>NL:</b> Nationale variant. <b>IT:</b> Variante per il Paese. <b>NO:</b> Variant i ulike land. <b>SV:</b> Landsvariant. <b>DA:</b> Landespecifik variant. <b>FI:</b> Maakohtainen vaihtelu. <b>ES:</b> Dependé del país. <b>PT:</b> Variante do país. <b>EL:</b> Έκδοση χώρας. <b>TR:</b> Ülkedeki model. <b>SL:</b> Jezikovna različica. <b>HR:</b> Ovisno o zemlji. <b>SK:</b> Vrsta ulja. <b>CS:</b> Varianta země. <b>PL:</b> Wersja dla kraju. <b>HU:</b> Országfüggő modellváltozatok. <b>RO:</b> Varianta țării. <b>BG:</b> Вариант за страната. <b>RU:</b> Региональное исполнение. <b>ET:</b> Riigi variant. <b>LV:</b> Valsts versija. <b>LT:</b> Šaliai skirtas variantas. <b>JA:</b> 国による相違。 <b>ZH:</b> 不同国家 <b>KO:</b> 국가별 모델. <b>TH:</b> แดกต่างกันไปตามประเทศ <b>MS:</b> Variasi negara.
2		V/ ph/ Hz	<b>EN:</b> Possible voltage. <b>DE:</b> Mögliche Spannung. <b>FR:</b> Tension autorisée. <b>NL:</b> Mogelijke spanning. <b>IT:</b> Possibile voltaggio. <b>NO:</b> Mulig spenning. <b>SV:</b> Möjlig spänning. <b>DA:</b> Spænding. <b>FI:</b> Mahdollinen jännite, V/vaiheluku/taajuus. <b>ES:</b> Tensión admitida. <b>PT:</b> Tensão possível. <b>EL:</b> Πιθανή τάση, V/ph/Frez. <b>TR:</b> Olası voltaj, V/Faz/Frekans. <b>SL:</b> Morebitna napetost. <b>HR:</b> Mogući napon. <b>SK:</b> Možné napätie. <b>CS:</b> Možné napětí. <b>PL:</b> Dopuszczalne napięcie, V/fazy/częst. <b>HU:</b> Tápészültség, V/fázis/frekv. <b>RO:</b> Tensiune posibilă, V/fază/Frecv. <b>BG:</b> Възможно напрежение. <b>RU:</b> Напряжение, В/ф./част. В/ф./Гц. <b>ET:</b> Võimalik pinge, V/faas/sagedus. <b>LV:</b> Iespējamais spriegums. <b>LT:</b> Galima įtampa V / F / Frez. <b>JA:</b> 電圧。 <b>ZH:</b> 可能电压 ( V/ph/Frez ) <b>KO:</b> 허용 전압, 볼트/상/헤르츠. <b>TH:</b> แรงดันไฟฟ้าที่สามารถใช้ได้ <b>MS:</b> Kemungkinan voltan.
3		A	<b>EN:</b> Fuse. <b>DE:</b> Sicherung. <b>FR:</b> Fusible. <b>NL:</b> Zekering. <b>IT:</b> Fusibile. <b>NO:</b> Sikring. <b>SV:</b> Säkring. <b>DA:</b> Sikring. <b>FI:</b> Sulake. <b>ES:</b> Fusible. <b>PT:</b> Fusível. <b>EL:</b> Ασφάλεια. <b>TR:</b> Sigorta. <b>SL:</b> Varovalka <b>HR:</b> Osigurač <b>SK:</b> Poistka <b>CS:</b> Pojistka. <b>PL:</b> Bezpiecznik. <b>HU:</b> Biztosíték. <b>RO:</b> Siguranță. <b>BG:</b> Предпазител <b>RU:</b> Предохранитель. <b>ET:</b> Kaitse. <b>LV:</b> Drošinātājs. <b>LT:</b> Saugiklis. <b>JA:</b> ヒューズ <b>ZH:</b> 保险丝 <b>KO:</b> 퓨즈. <b>TH:</b> ฟิวส์ <b>MS:</b> Fius
4		kW kBT	<b>EN:</b> Power rating. <b>DE:</b> Nennleistung. <b>FR:</b> Puissance nominale. <b>NL:</b> Nominiaal vermogen. <b>IT:</b> Corrente nominale. <b>NO:</b> Nominell effekt. <b>SV:</b> Märkeffekt. <b>DA:</b> Nominel effekt. <b>FI:</b> Tehontarve. <b>ES:</b> Potencia nominal. <b>PT:</b> Classificação de potência. <b>EL:</b> Ονομαστική ισχύς. <b>TR:</b> Elektrik değerleri. <b>SL:</b> Moč. <b>HR:</b> Oznaka napona. <b>SK:</b> Stanovenie výkonu. <b>CS:</b> Jmenovitý výkon. <b>PL:</b> Moc znamionowa. <b>HU:</b> Névleges teljesítmény. <b>RO:</b> Putere nominală. <b>BG:</b> Мощност. <b>RU:</b> Номинальная мощность кВт. <b>ET:</b> Vooluühik. <b>LV:</b> Nominālā jauda. <b>LT:</b> Galia. <b>JA:</b> 定格電力。 <b>ZH:</b> 额定功率 <b>KO:</b> 전원 등급. <b>TH:</b> อัตรากำลังไฟ <b>MS:</b> Penarafan kuasa.
5		A	<b>EN:</b> Current consumption. <b>DE:</b> Aktueller Verbrauch. <b>FR:</b> Consommation de courant. <b>NL:</b> Huidig verbruik. <b>IT:</b> Consumo di corrente. <b>NO:</b> Strømforbruk. <b>SV:</b> Strömförbrukning. <b>DA:</b> Strømforbrug. <b>FI:</b> Nykyinen kulutus. <b>ES:</b> Consumo actual. <b>PT:</b> Consumo de corrente. <b>EL:</b> Κατανάλωση ρεύματος. <b>TR:</b> Geçerli tüketim. <b>SL:</b> Poraba električne energije. <b>HR:</b> Potrošnja struje. <b>SK:</b> Aktuálna spotreba. <b>CS:</b> Odběr proudu. <b>PL:</b> Pobór prądu. <b>HU:</b> Áramfelvétel. <b>RO:</b> Consum de curent. <b>BG:</b> Консумация на електроенергия. <b>RU:</b> Текущий расход. <b>ET:</b> Praegune tarbimine. <b>LV:</b> Strāvas patēriņš. <b>LT:</b> Esamas suvartojimas. <b>JA:</b> 消費電流。 <b>ZH:</b> 电流消耗。 <b>KO:</b> 소비 전류. <b>TH:</b> กำลังไฟฟ้า <b>MS:</b> Penggunaan semasa.
6		bar Бар 巴	<b>EN:</b> Working pressure. <b>DE:</b> Arbeitsdruck. <b>FR:</b> Pression de service. <b>NL:</b> Werkdruk. <b>IT:</b> Pressione di esercizio. <b>NO:</b> Arbeidstrykk. <b>SV:</b> Arbetstryck. <b>DA:</b> Arbejdsryk. <b>FI:</b> Työpaine. <b>ES:</b> Presión de trabajo. <b>PT:</b> Pressão de trabalho. <b>EL:</b> Πίεση λειτουργίας. <b>TR:</b> Çalışma basıncı. <b>SL:</b> Delovni tlak. <b>HR:</b> Radni tlak. <b>SK:</b> Pracovní tlak. <b>CS:</b> Provozní tlak. <b>PL:</b> Ciśnienie robocze. <b>HU:</b> Üzemnyomás. <b>RO:</b> Presiune de lucru. <b>BG:</b> Работно налягане. <b>RU:</b> Рабочее давление. <b>ET:</b> Töösurve. <b>LV:</b> Darba spiediens. <b>LT:</b> Darbinis slėgis. <b>JA:</b> 動作圧力。 <b>ZH:</b> 工作压力 <b>KO:</b> 작업 압력. <b>TH:</b> แรงดันขณะใช้งาน <b>MS:</b> Tekanan kerja

7		l/min л/МИН 升/分钟	<b>EN:</b> Water flow. <b>DE:</b> Wasserdurchsatz. <b>FR:</b> Débit d'eau. <b>NL:</b> Waterdoorstroming. <b>IT:</b> Flusso dell'acqua. <b>NO:</b> Vanntilførsel. <b>SV:</b> Vattenflöde. <b>DA:</b> Vandmængde. <b>FI:</b> Vedenvirtaus. <b>ES:</b> Flujo de agua. <b>PT:</b> Fluxo de água. <b>EL:</b> Ποή νερού. <b>TR:</b> Su akışı. <b>SL:</b> Pretok vode. <b>HR:</b> Regulacija protoka vode. <b>SK:</b> Prietok vody. <b>CS:</b> Průtok vody. <b>PL:</b> Przepływ wody. <b>HU:</b> Vízátfolyás. <b>RO:</b> Debit apă. <b>BG:</b> Воден поток. <b>RU:</b> Расход воды. <b>ET:</b> Veevool. <b>LV:</b> Ūdens plūsma. <b>LT:</b> Vandens srautas. <b>JA:</b> 流水 <b>ZH:</b> 水流量 <b>KO:</b> 급수량 <b>TH:</b> การไหลของน้ำ <b>MS:</b> Aliran air.
8		bar Бар 巴	<b>EN:</b> Max. water pressure. <b>DE:</b> Max Wasserdruck. <b>FR:</b> Pression d'eau maximale. <b>NL:</b> Max. waterdruk. <b>IT:</b> Max. pressione dell'acqua. <b>NO:</b> Maks. vanntrykk. <b>SV:</b> Max vattentryck. <b>DA:</b> Max. vandtryk. <b>FI:</b> Suurin vedenpaine. <b>ES:</b> Presión máxima de entrada del agua. <b>PT:</b> Pressão máxima de água. <b>EL:</b> Μέγ. πίεση νερού. <b>TR:</b> Maks. su basıncı. <b>SL:</b> Najv. vodni tlak. <b>HR:</b> Maksimalni tlak vode. <b>SK:</b> Maximálny tlak vody. <b>CS:</b> Max. tlak vody. <b>PL:</b> Maks. ciśnienie wody. <b>HU:</b> Max. víznyomás. <b>RO:</b> Presiune max. apă. <b>BG:</b> Макс. налягане на водата. <b>RU:</b> Макс. давление воды. <b>ET:</b> Max veesurve. <b>LV:</b> Maks. ūdens spiediens. <b>LT:</b> Maks. vandens slėgis. <b>JA:</b> 最高水圧 <b>ZH:</b> 最大水压. <b>KO:</b> 최대 수압. <b>TH:</b> ความดันน้ำสูงสุด <b>MS:</b> Tekanan air maksimum.
9		l/min л/МИН 升/分钟	<b>EN:</b> Water flow <b>DE:</b> Wasserdurchsatz. <b>FR:</b> Débit d'eau. <b>NL:</b> Waterdoorstroming. <b>IT:</b> Flusso dell'acqua. <b>NO:</b> Vanntilførsel. <b>SV:</b> Vattenflöde. <b>DA:</b> Vandmængde. <b>FI:</b> Vedevirtaus. <b>ES:</b> Flujo de agua. <b>PT:</b> Fluxo de água. <b>EL:</b> Ποή νερού. <b>TR:</b> Su akışı. <b>SL:</b> Pretok vode. <b>HR:</b> Protok vode. <b>SK:</b> Prietok vody. <b>CS:</b> Průtok vody. <b>PL:</b> Przepływ wody. <b>HU:</b> Vízátfolyás. <b>RO:</b> Debit apă. <b>BG:</b> Воден поток. <b>RU:</b> Расход воды. <b>ET:</b> Veevool. <b>LV:</b> Ūdens plūsma. <b>LT:</b> Vandens srautas. <b>JA:</b> 流水. <b>ZH:</b> 水流量 <b>KO:</b> 급수량 <b>TH:</b> การไหลของน้ำ <b>MS:</b> Aliran air.
10			<b>EN:</b> High pressure nozzle <b>DE:</b> Hochdruckdüse. <b>FR:</b> Buse haute pression. <b>NL:</b> Hogedruksproeier. <b>IT:</b> Ugello alta pressione. <b>NO:</b> Høytrykksmunnstykke. <b>SV:</b> Högtrycksmunstycke. <b>DA:</b> Højtryksdyse. <b>FI:</b> Korkeapainesuutin. <b>ES:</b> Boquilla de alta presión. <b>PT:</b> Bocal de alta pressão. <b>EL:</b> Ακροφύσιο υψηλής πίεσης. <b>TR:</b> Yüksek basınçlı ağız. <b>SL:</b> Šoba za visoki pritisk. <b>HR:</b> Visokotlačna mlaznica. <b>SK:</b> Vysokotlaková hubica. <b>CS:</b> Vysokotlaková tryska. <b>PL:</b> Dysza wysokociśnieniowa. <b>HU:</b> Nagynyomású fúvóka. <b>RO:</b> Duză de înaltă presiune. <b>BG:</b> Дюза за високо налягане. <b>RU:</b> Сопло высокого давления. <b>ET:</b> Kõrgsurve otsak. <b>LV:</b> Augstspiediena sprausla. <b>LT:</b> Aukšto slėgio purkštukas. <b>JA:</b> 高压カノズル. <b>ZH:</b> 高压喷嘴. <b>KO:</b> 고압 노즐 <b>TH:</b> หัวฉีดแรงดันสูง <b>MS:</b> Nozel tekanan tinggi.
11		°C	<b>EN:</b> Water Temperature. <b>DE:</b> Wasser temperatur. <b>FR:</b> d'eau température. <b>NL:</b> Water temperatuur. <b>IT:</b> dell'acqua temperatura. <b>NO:</b> Vann temperatur. <b>SV:</b> Vatten temperatur. <b>DA:</b> Vandtemperatur. <b>FI:</b> Veden lämpötila. <b>ES:</b> agua temperatura. <b>PT:</b> água temperatura. <b>EL:</b> νερού θερμοκρασία. <b>TR:</b> Su sıcaklık. <b>SL:</b> vode temperatura. <b>HR:</b> vode temperatura. <b>SK:</b> vody teplota. <b>CS:</b> vody teplota. <b>PL:</b> wody temperatura. <b>HU:</b> Viz hőmérséklet. <b>RO:</b> apă temperatură. <b>BG:</b> Воден температура. <b>RU:</b> воды температура. <b>ET:</b> Vee temperatuur. <b>LV:</b> Ūdens temperatūra. <b>LT:</b> Vandens temperatūra. <b>JA:</b> 水温度. <b>ZH:</b> 水温度. <b>KO:</b> 물 온도. <b>TH:</b> น้ำอุณหภูมิที่ไซ <b>MS:</b> Air Suhu yang.

12		°C	<p><b>EN:</b> Max water inlet temperature, Intake-Pressure operation. <b>DE:</b> Max Wassereinlassstemperatur - Druckbetrieb. <b>FR:</b> Température max. de l'entrée d'eau en mode admission/pression. <b>NL:</b> Max. Waterinlaattemperatuur Inlaat-Tijdens. Bedrijf. <b>IT:</b> Temperatura max. alimentazione acqua Funzionamento a ingressopressione. <b>NO:</b> Maks. temperatur vanninntak, Inntakstrykk drift. <b>SV:</b> Max ingående vattentemperatur inlopps-tryckdrift. <b>DA:</b> Maks. vandtilgangstemperatur, tilgangstrykdrift. <b>FI:</b> Tuloveden suurin lämpötila, käytettäessä painepesurina. <b>ES:</b> Temperatura y presión máxima de entrada del agua. <b>PT:</b> Temperatura máxima de entrada de água, Funcionamento da pressão de entrada. <b>EL:</b> Μεγ. θερμοκρασία εισόδου νερού-λειτουργίας πίεσης. <b>TR:</b> Maks. su girişi sıcaklığı Emme-Basınçlı çalışma. <b>SL:</b> Najv. vstopna temperatura vode, vstopni tlak pri delovanju. <b>HR:</b> Maks. temperatura ulazne vode, tlak pri usisavanju. <b>SK:</b> Max. vstupná teplota vody, Prevádzka v nasávacom režime pod tlakom. <b>CS:</b> Max. teplota vody na vstupu, provozní sací tlak. <b>PL:</b> Maks. temperatura na dopływie wody z instalacji wodociągowej. <b>HU:</b> Max. bemenő vízhőmérséklet Szívónyomásos üzem. <b>RO:</b> Temperatura max. de admisie apă în cazul alimentării de la robinet. <b>BG:</b> Макс. температура на входящата вода – работа в режим на засмукване. <b>RU:</b> Макс. температура воды на входе (всасывание/подача под давлением). <b>ET:</b> Max vee sisselasketemperatuur Sissevõturihk töö ajal. <b>LV:</b> Maks. ūdens ieplūdes temperatūra ieplūdes-spiediena darbībā. <b>LT:</b> Didžiausia vandens paėmimo temperatūra, veikimas esant jėjimo slėgiui. <b>JA:</b> 最高流入水温度、吸気圧力動作。 <b>ZH:</b> 进水压力操作时的最高进水水温 <b>KO:</b> 최대 급수 온도 주입/압력 작동. <b>TH:</b> อุณหภูมิน้ำเข้าสูงสุด ความดันในการใช้งานบริเวณทางเข้า <b>MS:</b> Suhu maksimum air masuk, Kemasukan-Operasi tekanan.</p>
13		bar Бар 巴	<p><b>EN:</b> Max. water inlet pressure. <b>DE:</b> Max. Wassereinlassdruck. <b>FR:</b> d'eau en mode admission/pression. <b>NL:</b> Max. waterinlaatdruk. <b>IT:</b> Pressione max. alimentazione acqua. <b>NO:</b> Maks. trykk vanninntak. <b>SV:</b> Max tryck för vatteninlopp. <b>DA:</b> Maks. Vandtilgangstryk. <b>FI:</b> Tuloveden suurin paine. <b>ES:</b> Presión máxima de entrada del agua. <b>PT:</b> Pressão máxima de entrada de água. <b>EL:</b> Μεγ. πίεση εισόδου νερού. <b>TR:</b> Maks. su girişi basıncı. <b>SL:</b> Najv. tlak dovoda vode. <b>HR:</b> Maks. tlak ulazne vode. <b>SK:</b> Max. vstupný tlak vody. <b>CS:</b> Max. tlak vody na vstupu. <b>PL:</b> Maks. ciśnienie na dopływie wody. <b>HU:</b> Max. bemenő nyomás. <b>RO:</b> Presiunea max. de alimentare cu apă. <b>BG:</b> Макс. налягане на входяща вода. <b>RU:</b> Макс. давление воды на входе. <b>ET:</b> Maks vee sissevoolusurve. <b>LV:</b> Maks. ūdens spiediens. <b>LT:</b> Didžiausias vandens paėmimo slėgis. <b>JA:</b> 最高流入水圧。 <b>ZH:</b> 最大进水压力 <b>KO:</b> 최고 급수 압력. <b>TH:</b> ความดันน้ำเข้าสูงสุด <b>MS:</b> Tekanan maksimum air masuk.</p>
14		mm 毫米	<p><b>EN:</b> Dimensions LxWxH. <b>DE:</b> Masse LxBxH. <b>FR:</b> Dimensions l x p x h. <b>NL:</b> Afmetingen LxBxH. <b>IT:</b> Dimensioni, lun. x larg. x alt. <b>NO:</b> Mål LxBxH. <b>SV:</b> Dimensioner LxBxH. <b>DA:</b> Mål LxBxH. <b>FI:</b> Mitat, PxLxK. <b>ES:</b> Dimensiones l x a x al. <b>PT:</b> Dimensões, C x L x A. <b>EL:</b> Διαστάσεις, Μ x Π x Υ. <b>TR:</b> Boyutlar, u x g x y. <b>SL:</b> Mere D x Š x V. <b>HR:</b> Dimenzije DxŠxV. <b>SK:</b> Rozmery D x Š x V. <b>CS:</b> Rozměry d x š x v. <b>PL:</b> Wymiary długo. x szer. x wys. <b>HU:</b> Méretek H x Sz x M. <b>RO:</b> Dimensiuni. L x l x î. <b>BG:</b> Размери Д x Ш x В. <b>RU:</b> Размеры, Дл. x Шир. x Выс. <b>ET:</b> Mõõtmed p x l x k. <b>LV:</b> Izmēri G x P x A. <b>LT:</b> Matmenys (l x p x a). <b>JA:</b> 外形寸法長さx幅x高さ。 <b>ZH:</b> 尺寸 (长 x 宽 x 高) 毫米 <b>KO:</b> 크기 (l x w x h). <b>TH:</b> ขนาด ยาว x กว้าง x สูง <b>MS:</b> Dimensi LxWxH.</p>
15		kg кг	<p><b>EN:</b> Weight. <b>DE:</b> Gewicht. <b>FR:</b> Poids du nettoyeur. <b>NL:</b> Gewicht van de hogedrukreiniger. <b>IT:</b> Peso dell'idropulitrice. <b>NO:</b> Vekt høytrykksvasker. <b>SV:</b> Maskinens vikt. <b>DA:</b> Vægt. <b>FI:</b> Pelkän painepesurin paino. <b>ES:</b> Peso del limpiador. <b>PT:</b> Peso da máquina de limpeza. <b>EL:</b> Βάρος μηχανήματος καθαρισμού. <b>TR:</b> Temizlik makinesinin yüksekliği. <b>SL:</b> Masa. <b>HR:</b> Težina. <b>SK:</b> Hmotnosť. <b>CS:</b> Hmotnost čisticího stroje. <b>PL:</b> Ciężar myjki. <b>HU:</b> Tisztítógép tömege. <b>RO:</b> Greutatea aparatului. <b>BG:</b> Тегло. <b>RU:</b> Вес моечной машины. <b>ET:</b> Pesuri kaal. <b>LV:</b> Tīrītāja svars. <b>LT:</b> Valymo įrenginio svoris. <b>JA:</b> 重量。 <b>ZH:</b> 清洗机重量 <b>KO:</b> 세척기 무게. <b>TH:</b> น้ำหนัก <b>MS:</b> Berat.</p>



16	 L <sub>PA</sub> (IEC 60335-2-79)	dB(A) дБ(A)	<b>EN:</b> Sound pressure level L <sub>PA</sub> <b>DE:</b> Schalldruckpegel <b>FR:</b> Niveau de pression acoustique <b>NL:</b> Geluidsdrukniveau <b>IT:</b> Livello pressione sonora <b>NO:</b> Lydtrykknivå <b>SV:</b> Ljudtrycksnivå <b>DA:</b> Lydtryksniveau <b>FI:</b> Äänenpainetaso <b>ES:</b> Nivel de presión sonora <b>PT:</b> Nível de pressão acústica <b>EL:</b> Επίπεδο πίεσης ήχου <b>TR:</b> Göre ses basıncı seviyesi <b>SL:</b> Raven zvočnega tlaka. <b>HR:</b> Razina zvučnog tlaka. <b>SK:</b> Hladina zvukového. <b>CS:</b> Hladina akustického tlaku <b>PL:</b> Poziom ciśnienia akustycznego <b>HU:</b> Hangnyomásszint <b>RO:</b> Nivel de presiune acustică <b>BG:</b> Ниво на звуково налягане <b>RU:</b> Уровень шума <b>ET:</b> Helisurve tase <b>LV:</b> Akustiskā spiediena līmenis <b>LT:</b> Garso slėgio lygis <b>JA:</b> 音圧レベル <b>ZH:</b> 声压级 <b>KO:</b> 음압 레벨 <b>TH:</b> ระดับความดันเสียง <b>MS:</b> Tahap tekanan bunyi
17	 L <sub>WA</sub> (IEC 60335-2-79)	dB(A) дБ(A)	<b>EN:</b> Sound power level L <sub>WA</sub> <b>DE:</b> Schallleistungspegel <b>FR:</b> Niveau de puissance acoustique <b>NL:</b> Geluidsvermogeniveau <b>IT:</b> Livello potenza sonora <b>NO:</b> Lydeffektnivå <b>SV:</b> Ljudeffektnivå <b>DA:</b> Lydeffektniveau <b>FI:</b> Äänen tehotaaso <b>ES:</b> Potencia acústica <b>PT:</b> Nível de potência acústica <b>EL:</b> Επίπεδο ισχύος ήχου <b>TR:</b> Göre ses basıncı seviyesi <b>SL:</b> Raven moči zvoka. <b>HR:</b> Razina jakosti. <b>SK:</b> Hladina zvukového výkonu. <b>CS:</b> Hladina akustického výkonu <b>PL:</b> Poziom mocy akustycznej <b>HU:</b> Hangteljesítmény szint <b>RO:</b> Nivelul de putere acustică <b>BG:</b> Ниво на звукова мощност <b>RU:</b> Уровень звуковой мощности <b>ET:</b> Helivõimsuse tase <b>LV:</b> Akustiskās jaudas līmenis <b>LT:</b> Garso galios lygis <b>JA:</b> 音響パワーレベル <b>ZH:</b> 声功率级 <b>KO:</b> 소음 레벨 <b>TH:</b> ระดับกำลังเสียง <b>MS:</b> Tahap kuasa bunyi
18	 a <sub>h</sub> (ISO 5349 a <sub>h</sub> )	m/s <sup>2</sup> 米/秒 <sup>2</sup>	<b>EN:</b> Vibration. <b>DE:</b> Vibrationen <b>FR:</b> Vibration <b>NL:</b> Vibratie <b>IT:</b> Vibrazioni <b>NO:</b> Vibrasjoner <b>SV:</b> Vibration <b>DA:</b> Vibration <b>FI:</b> Tärinäarvot <b>ES:</b> Vibración <b>PT:</b> Vibração <b>EL:</b> Δόνηση <b>TR:</b> Titreşimi <b>SL:</b> Vibracije. <b>HR:</b> Vibracije. <b>SK:</b> Vibrácie. <b>CS:</b> Vibrace <b>PL:</b> Drgania <b>HU:</b> Vibráció <b>RO:</b> Vibrații <b>BG:</b> Вибрации. <b>RU:</b> Вибрация <b>ET:</b> vibratsioon <b>LV:</b> vibrācija <b>LT:</b> Vibracijos <b>JA:</b> 振動. <b>ZH:</b> 振动 <b>KO:</b> 진동 <b>TH:</b> แรงสั่นสะเทือน <b>MS:</b> Getaran.
19		N	<b>EN:</b> Recoil forces, lance. <b>DE:</b> Rückstoßkraft, Sprühhrohr <b>FR:</b> Forces de recul, lance <b>NL:</b> Terugslagkracht, lans <b>IT:</b> Forze di rinculo, lancia <b>NO:</b> Rekylkraft, lanse <b>SV:</b> Rekylkraft, spolrör <b>DA:</b> Rekylkraft, dyserør <b>FI:</b> Rekyylivoimat, suutin <b>ES:</b> Fuerzas de retroceso, lanza <b>PT:</b> Forças de retrocesso, lança <b>EL:</b> Δυνάμεις οπισθοδρόμησης, διάταξη ψεκασμού χη. <b>TR:</b> Sarmal kuvvetler, boru <b>SL:</b> Povratne sile, šoba. <b>HR:</b> Trzajne sile, mlaznica. <b>SK:</b> Spätný odraz, štandardná striekacia rúra. <b>CS:</b> Síly zpětného rázu, násadec <b>PL:</b> Siły odrzutu, lanca <b>HU:</b> Visszaható erő, szórócső <b>RO:</b> Forțe de recul, tijă <b>BG:</b> Сили на откат, крайник. <b>RU:</b> Сила отдачи (распылитель). <b>ET:</b> Tagasilöögi jõud, otsik <b>LV:</b> Atsitiena spēks, smidzinātājs <b>LT:</b> Atatrankos jėga, antgalis, <b>JA:</b> 反跳力、ランス。 <b>ZH:</b> 反冲力 ( 喷杆 ) <b>KO:</b> 반동력, 랜스 <b>TH:</b> แรงสะท้อน ถอยหลัง, ปลายทอ <b>MS:</b> Kuasa sentakan, lans.
20	 TYPE	L л 升	<b>EN:</b> Oil quantity, type. <b>DE:</b> Ölmenge, typ. <b>FR:</b> Quantité d'huile, type. <b>NL:</b> Hoeveelheid olie, type. <b>IT:</b> Quantità di olio, tipo. <b>NO:</b> Oljemengde, type. <b>SV:</b> Oljemängd, typ. <b>DA:</b> Oliemængde, type. <b>FI:</b> Öljymäärä, tyyppi. <b>ES:</b> Cantidad de aceite, tipo. <b>PT:</b> Quantidade de óleo, tipo. <b>EL:</b> Ποσότητα λαδιού, τύπος. <b>TR:</b> Yağ miktarı, tipi. <b>SL:</b> Količina olja, vrsta. <b>HR:</b> Količina ulja, vrsta. <b>SK:</b> Množstvo oleja, typ. <b>CS:</b> Množství oleje, typ. <b>PL:</b> Mnożstwo oleje, typ. <b>HU:</b> Olajmennyiség, típusa. <b>RO:</b> Cantitate de ulei, tip. <b>BG:</b> Количество масло, Тип. <b>RU:</b> Количество масла, Тип. <b>ET:</b> õli kogus, tüüp. <b>LV:</b> Eļļas daudzums, tips. <b>LT:</b> alyvos kiekis, tipas. <b>JA:</b> オイル量種類。 <b>ZH:</b> 猴祇 类型 <b>KO:</b> 오일량, 유형. <b>TH:</b> ปริมาณน้ำมันเครื่อง ประเภท <b>MS:</b> Kuantiti minyak, jenis.
21		kW кВт	<b>EN:</b> Heating capacity. <b>DE:</b> Heizleistung. <b>FR:</b> Puissance calorifique. <b>NL:</b> Verwarmingscapaciteit. <b>IT:</b> Potenza termica. <b>NO:</b> Varmekapasitet. <b>SV:</b> Värmeeffekt. <b>DA:</b> Opvarmningskapacitet. <b>FI:</b> Lämmitysteho. <b>ES:</b> Capacidad de calentamiento. <b>PT:</b> Capacidade de aquecimento. <b>EL:</b> Θερμική απόδοση. <b>TR:</b> Isıtma kapasitesi. <b>SL:</b> Zmogljivost gretja. <b>HR:</b> Kapacitet grijanja. <b>SK:</b> Ohrevný výkon. <b>CS:</b> Tepelný výkon. <b>PL:</b> Moc grzewcza. <b>HU:</b> Fűtőteljesítmény. <b>RO:</b> Capacitate de încălzire. <b>BG:</b> Отоплителна мощност. <b>RU:</b> Мощность нагрева. <b>ET:</b> Küttevõimsus. <b>LV:</b> Sildīšanas jauda. <b>LT:</b> Šildymo galia. <b>JA:</b> 加熱能力。 <b>ZH:</b> 热容量。 <b>KO:</b> 가열 용량. <b>TH:</b> ความจุความร้อน <b>MS:</b> Kapasiti pemanasan.

22		L л 升	<p><b>EN:</b> Fuel tank. <b>DE:</b> Kraftstofftank. <b>FR:</b> Réservoir de carburant. <b>NL:</b> Brandstoftank. <b>IT:</b> Serbatoio carburante. <b>NO:</b> Drivstoffbeholder. <b>SV:</b> Bränsletank. <b>DA:</b> Brændstofftank. <b>FI:</b> Polttoainesäiliö. <b>ES:</b> Depósito de combustible. <b>PT:</b> Depósito de combustível. <b>EL:</b> Πεζερβουάρ καυσίμου. <b>TR:</b> Yakıt deposu. <b>SL:</b> Posoda za gorivo. <b>HR:</b> Spremnik goriva. <b>SK:</b> Palivová nádrž. <b>CS:</b> Palivová nádrž. <b>PL:</b> Zbiornik paliwa. <b>HU:</b> Üzemanyagtartály. <b>RO:</b> Rezervor de combustibil. <b>BG:</b> Резервоар за гориво. <b>RU:</b> Топливный бак. <b>ET:</b> Kütusepaak. <b>LV:</b> Degvielas tvertne. <b>LT:</b> Kuro bakas. <b>JA:</b> 燃料タンク。 <b>ZH:</b> 油箱。 <b>KO:</b> 연료 탱크. <b>TH:</b> ถังเชื้อเพลิง <b>MS:</b> Tangki bahan api.</p>
23		L л 升	<p><b>EN:</b> Detergent tank A/B. <b>DE:</b> Reinigungsmittelbehälter A/B. <b>FR:</b> Réservoir de détergent A/B. <b>NL:</b> Reinigingsmiddeltank A/B. <b>IT:</b> Serbatoio del detergente A/B. <b>NO:</b> Vaskemiddelbeholder A/B. <b>SV:</b> Tank för rengöringsmedel A/B. <b>DA:</b> Rengøringsmiddeltank A/B. <b>FI:</b> Pesuainesäiliö A/B. <b>ES:</b> Depósito de detergente A/B. <b>PT:</b> Depósito de detergente A/B. <b>EL:</b> Πεζερβουάρ απορρυπαντικών A/B. <b>TR:</b> Deterjan deposu A/B. <b>SL:</b> Posoda za detergent A/B. <b>HR:</b> Spremnik za deterđent A/B. <b>SK:</b> Nádoaba na čistiaci prostriedok A/B. <b>CS:</b> Nádrž na čistící prostředek A/B. <b>PL:</b> Zbiornik na plyn do czyszczenia A/B. <b>HU:</b> Tisztítószerartály A/B. <b>RO:</b> Rezervor de detergent A/B. <b>BG:</b> Резервоар за почистващ препарат A/B. <b>RU:</b> Бак с моющим средством A/B. <b>ET:</b> Puhastusvahendi paak A/B. <b>LV:</b> Mazgāšanas līdzekļu tvertne A/B. <b>LT:</b> Ploviklio bakas A/B. <b>JA:</b> 洗剤タンクA/B。 <b>ZH:</b> 洗涤剂箱 A/B。 <b>KO:</b> 세제 탱크 A/B. <b>TH:</b> ถังสารซักฟอก A/B <b>MS:</b> Tangki detergent A/B.</p>
24	<p><b>EN:</b> Specifications and details are subject to change without prior notice. <b>DE:</b> Technische Daten und Details des Geräts können sich ohne vorherige Ankündigung ändern. <b>FR:</b> Ces spécifications et détails sont susceptibles d'être modifiés sans préavis. <b>NL:</b> Specificaties en details kunnen zonder voorafgaande waarschuwing worden gewijzigd. <b>IT:</b> Specifiche e dettagli sono soggetti a modifiche senza preavviso. <b>NO:</b> Spesifikasjonene og detaljene er gjenstand for endringer uten forutgående varsel. <b>SV:</b> Specifikationer och information kan ändras utan föregående meddelande. <b>DA:</b> Ret til ændringer i konstruktion og specifikationer forbeholdes. <b>FI:</b> Rakenteeseen ja teknisiin tietoihin voidaan tehdä muutoksia ilmoittamatta niistä ennalta. <b>ES:</b> Las especificaciones y los datos están sujetos a cambios sin previo aviso. <b>PT:</b> As especificações e os detalhes estão sujeitos a alterações sem aviso prévio. <b>EL:</b> Τα τεχνικά χαρακτηριστικά και οι λεπτομέρειες υπόκεινται σε αλλαγές χωρίς προηγούμενη ειδοποίηση. <b>TR:</b> Özellikler ve ayrıntılar, önceden haber verilmeden değiştirilebilir. <b>SL:</b> Tehnični podatki in podrobnosti se lahko spremenijo brez predhodnega obvestila. <b>HR:</b> Specifikacije i detalji mogu se mijenjati bez prethodne najave. <b>SK:</b> Špecifikácie a podrobnosti sa môžu meniť bez predchádzajúceho upozornenia. <b>CS:</b> Technické údaje a detaily mohou být změněny i bez předchozího upozornění. <b>PL:</b> Specyfikacje i parametry mogą zostać zmienione bez uprzedzenia. <b>HU:</b> A műszaki adatok és részletek előzetes értesítés nélkül megváltozhatnak. <b>RO:</b> Specificațiile și detaliile pot fi modificate fără înștiințare prealabilă. <b>BG:</b> Спецификациите и детайлите подлежат на промяна без предварително уведомление. <b>RU:</b> Технические характеристики и данные могут изменяться без предварительного извещения. <b>ET:</b> Tehnilisi kirjeldusi ja üksikasju võidakse muuta eelneva etteteatamiseta. <b>LV:</b> Specifikācijas un detaļas var tikt mainītas bez iepriekšēja paziņojuma. <b>LT:</b> Konstrukcija ir specifikacijos gali keistis be išankstinio įspėjimo. <b>JA:</b> 仕様および情報は事前通知無しに変更する場合があります。 <b>ZH:</b> 规格和详情如有变更，恕不另行通知。 <b>KO:</b> 사양 및 내용은 예고없이 변경될 수 있습니다. <b>TH:</b> ข้อกำหนดเฉพาะและรายละเอียดสามารถเปลี่ยนแปลงได้โดยไม่ต้องแจ้งให้ทราบล่วงหน้า <b>MS:</b> Spesifikasi dan butiran adalah tertakluk kepada perubahan tanpa notis terlebih dahulu.</p>		





## HEAD QUARTER

### DENMARK

Nilfisk A/S  
Kornmarksvej 1  
DK-2605 Broendby  
Tel.: (+45) 4323 8100  
www.nilfisk.com

## SALES COMPANIES

### ARGENTINA

Nilfisk srl.  
Edificio Central Park  
Herrera 1855, 6th floor/604  
Ciudad de Buenos Aires  
Tel.: (+54) 11 6091 1571  
www.nilfisk.com.ar

### AUSTRALIA

Nilfisk Pty Ltd  
Unit 1/13 Bessemer Street  
Blacktown NSW 2148  
Tel.: (+61) 2 98348100  
www.nilfisk.com.au

### AUSTRIA

Nilfisk GmbH  
Metzgerstrasse 68  
5101 Bergheim bei Salzburg  
Tel.: (+43) 662 456 400 90  
www.nilfisk.at

### BELGIUM

Nilfisk n.v.-s.a.  
Riverside Business Park  
Boulevard Internationalelaan 55  
Bâtiment C3/C4 Gebouw  
Bruxelles 1070  
Tel.: (+32) 14 67 60 50  
www.nilfisk.be

### BRAZIL

Nilfisk do Brasil  
Av. Eng. Luis Carlos Berrini, 550  
40 Andar, Sala 03  
SP - 04571-000 Sao Paulo  
Tel.: (+11) 3959-0300 / 3945-4744  
www.nilfisk.com.br

### CANADA

Nilfisk Canada Company  
240 Superior Boulevard  
Mississauga, Ontario L5T 2L2  
Tel.: (+1) 800-668-8400  
www.nilfisk.ca

### CHILE

Nilfisk S.A. (Comercial KCS Ltda)  
Salar de Llamara 822  
8320000 Santiago  
Tel.: (+56) 2684 5000  
www.nilfisk.cl

### CHINA

Nilfisk  
4189 Yindu Road  
Xinzhuan Industrial Park  
201108 Shanghai  
Tel.: (+86) 21 3323 2000  
www.nilfisk.cn

### CZECH REPUBLIC

Nilfisk s.r.o.  
VGP Park Horní Počernice  
Do Čertous 1/2658  
193 00 Praha 9  
Tel.: (+420) 244 090 912  
www.nilfisk.cz

### DENMARK

Nilfisk Danmark A/S  
Industrivej 1  
Hadsund, DK-9560  
Tel.: 72 18 21 20  
www.nilfisk.dk

### FINLAND

Nilfisk Oy Ab  
Koskelontie 23 E  
02920 Espoo  
Tel.: (+358) 207 890 600  
www.nilfisk.fi

### FRANCE

Nilfisk SAS  
26 Avenue de la Baltique  
Villebon sur Yvette  
91978 Courtabouef Cedex  
Tel.: (+33) 169 59 87 00  
www.nilfisk.fr

### GERMANY

Nilfisk GmbH  
Guido-Oberdorfer-Straße 2-10  
89287 Bellenberg  
Tel.: (+49) (0)7306/72-444  
www.nilfisk.de

### GREECE

Nilfisk A.E.  
Αναπαύσεως 29  
Κορωπί T.K. 194 00  
Tel.: (30) 210 9119 600  
www.nilfisk.gr

### HOLLAND

Nilfisk B.V.  
Versterkerstraat 5  
1322 AN Almere  
Tel.: (+31) 036 5460760  
www.nilfisk.nl

### HONG KONG

Nilfisk Ltd.  
2001 HK Worsted Mills  
Industrial Building  
31-39, Wo Tong Tsui St.  
Kwai Chung, N.T.  
Tel.: (+852) 2427 5951  
www.nilfisk.com

### HUNGARY

Nilfisk Kft.  
II. Rákóczi Ferenc út 10  
2310 Szigetszentmiklós-Lakihegy  
Tel.: (+36) 24 475 550  
www.nilfisk.hu

### INDIA

Nilfisk India Limited  
Pramukh Plaza, 'B' Wing, 4th floor, Unit  
No. 403  
Cardinal Gracious Road, Chakala  
Andheri (East) Mumbai 400 099  
Tel.: (+91) 22 6118 8188  
www.nilfisk.in

### IRELAND

Nilfisk  
1 Stokes Place  
St. Stephen's Green  
Dublin 2  
Tel.: (+35) 3 12 94 38 38  
www.nilfisk.ie

### ITALY

Nilfisk SpA  
Strada Comunale della Braglia, 18  
26862 Guardamiglio (LO)  
Tel.: (+39) (0) 377 414021  
www.nilfisk.it

### JAPAN

Nilfisk Inc.  
1-6-6 Kita-shinyokohama, Kouhoku-ku  
Yokohama, 223-0059  
Tel.: (+81) 45548 2571  
www.nilfisk.com

### MALAYSIA

Nilfisk Sdn Bhd  
Sd 33, Jalan KIP 10  
Taman Perindustrian KIP  
Sri Damansara  
52200 Kuala Lumpur  
Tel.: (60) 3603 627 43 120  
www.nilfisk.com

### MEXICO

Nilfisk de Mexico, S. de R.L. de C.V.  
Pirineos #515 Int.  
60-70 Microparque  
Industrial WSantiago  
76120 Queretaro  
Tel.: (+52) (442) 427 77 00  
www.nilfisk.com

### NEW ZEALAND

Nilfisk Limited  
Suite F, Building E  
42 Tawa Drive  
0632 Albany Auckland  
Tel.: (+64) 9 414 1996  
Website: www.nilfisk.com

### NORWAY

Nilfisk AS  
Bjørnerudveien 24  
1266 Oslo  
Tel.: (+47) 22 75 17 80  
www.nilfisk.no

### PERU

Nilfisk S.A.C.  
Calle Boulevard 162, Of. 703, Lima 33-  
Perú  
Lima  
Tel.: (511) 435-6840  
www.nilfisk.com

### POLAND

Nilfisk Sp. Z.O.O.  
Millenium Logistic Park  
ul. 3 Maja 8, Bud. B4  
05-800 Pruszków  
Tel.: (+48) 22 738 3750  
www.nilfisk.pl

### PORTUGAL

Nilfisk Lda.  
Sintra Business Park  
Zona Industrial Da Abrunheira  
Edificio 1, 1° A  
P2710-089 Sintra  
Tel.: (+351) 21 911 2670  
www.nilfisk.pt

### RUSSIA

Nilfisk LLC  
Vyatskaya str. 27, bld. 7/1st  
127015 Moscow  
Tel.: (+7) 495 783 9602  
www.nilfisk.ru

### SINGAPORE

Den-Sin  
22 Tuas Avenue 2  
639453 Singapore  
Tel.: (+65) 6268 1006  
www.densin.com

### SLOVAKIA

Nilfisk s.r.o.  
Bancíkovej 1/A  
SK-821 03 Bratislava  
Tel.: (+421) 910 222 928  
www.nilfisk.sk

### SOUTH AFRICA

WAP South Africa  
12 Newton Street  
Spartan 1630  
Tel.: (+27) 11 975 7060  
www.wap.com.za

### SOUTH KOREA

Nilfisk Korea  
3F Duksoo B/D, 317-15  
Sungsoo-Dong 2Ga  
Sungdong-Gu, Seoul  
Tel.: (+82) 2497 8636  
www.nilfisk.co.kr

### SPAIN

Nilfisk S.A.  
Torre d'Ara,  
Passeig del Rengle, 5 Plta. 10ª  
08302 Mataró  
Tel.: (34) 93 741 2400  
www.nilfisk.es

### SWEDEN

Nilfisk AB  
Taljegårdsgatan 4  
431 53 Möndal  
Tel.: (+46) 31 706 73 00  
www.nilfisk.se

### SWITZERLAND

Nilfisk AG  
Ringstrasse 19  
Kircheberg/Industri Stelz  
9500 Wil  
Tel.: (+41) 71 92 38 444  
www.nilfisk.ch

### TAIWAN

Nilfisk Ltd  
Taiwan Branch (H.K)  
No. 5, Wan Fang Road  
Taipei  
Tel.: (+88) 6227 00 22 68  
www.nilfisk.tw

### THAILAND

Nilfisk Co. Ltd.  
89 Soi Chokechai-Ruammitr  
Viphavadee-Rangsit Road  
Ladyao, Jatuchak, Bangkok 10900  
Tel.: (+66) 2275 5630  
www.nilfisk.co.th

### TURKEY

Nilfisk A.S.  
Serifali Mh. Bayraktar Bulv. Sehit Sk. No:7  
Ümraniye, 34775 Istanbul  
Tel.: +90 216 466 94 94  
www.nilfisk.com.tr

### UNITED ARAB EMIRATES

Nilfisk Middle East Branch  
SAIF-Zone  
P.O. Box 122298  
Sharjah  
Tel.: (+971) (0) 655-78813  
www.nilfisk.com

### UNITED KINGDOM

Nilfisk Ltd.  
Nilfisk House, Bowerbank Way  
Gilwilly Industrial Estate, Penrith  
Cumbria CA11 9BQ  
Tel.: (+44) (0) 1768 868995  
www.nilfisk.co.uk

### UNITED STATES

Nilfisk, Inc.  
9435 Winnetka Ave N,  
Brooklyn Park  
MN- 55445  
www.nilfisk.com

### VIETNAM

Nilfisk Vietnam  
No. 51 Doc Ngu Str.  
P. Vinh Phúc, Q.Ba Dinh  
Hanoi  
Tel.: (+84) 761 5642  
www.nilfisk.com